

HarmonicPlanetary[®]

HPG Right Angle Series

Size

32, 50, 65

3
Sizes

Peak torque

150Nm – 2200Nm

Reduction ratio

Single Stage: 5:1, Two Stage: 11:1 to 50:1

Low backlash

<3 arc-min Low Backlash for Life

Innovative ring gear inherently compensates for interference between meshing parts, ensuring consistent, low backlash for the life of the gearhead.

High efficiency

Up to 92%

High Load Capacity Output Bearing

A Cross Roller bearing is integrated with the output flange to provide high moment stiffness, high load capacity and precise positioning accuracy.

Easy mounting to a wide variety of servomotors

Quick Connect[®] coupling

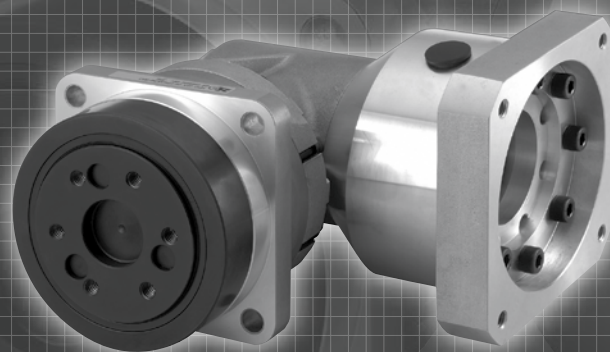

CONTENTS

Rating Table.....	53
Performance.....	54
Backlash and Torsional Stiffness	55
Outline Dimensions	56-59
Product Sizing & Selection.....	60-61

HPG - 32 A - 05 - J2 - RA3 - Motor Code

Model Name	Size	Design Revision	Reduction Ratio	Output Configuration	Right Angle Specification	Input Configuration
HarmonicPlanetary [®] HPG Right Angle	32	A	5, 11, 15, 21, 33, 45	F0: Flange output J2: Shaft output without key	RA3	This code represents the motor mounting configuration. Please contact us for a unique part number based on the motor you are using.
	50			J6: Shaft output with key and center tapped hole	RA3, RA5	
	65		5, 12, 15, 20, 25, 40, 50		RA5	

Gearhead Construction

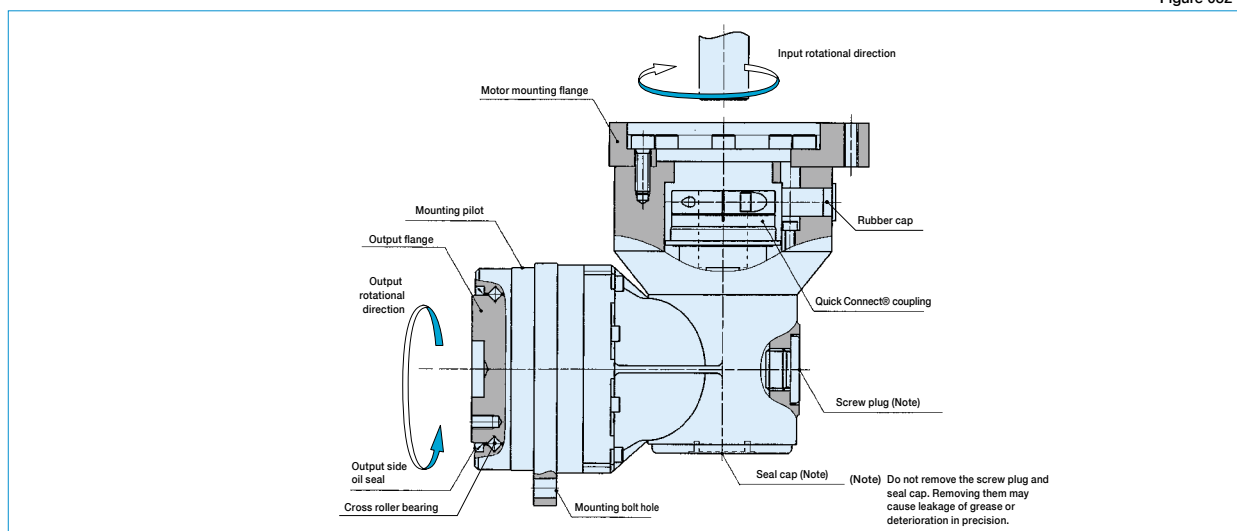

Figure 052-1

Rating Table

Table 053-1

Size	Model	Ratio	Rated Torque L10 *1	Rated Torque L50 *1	Limit for Average Load Torque *2	Limit for Repeated Peak Torque *3	Limit for Momentary Torque *4	Max. Average Input Speed *5	Max. Input Speed *6
			Nm	Nm	Nm	Nm	Nm	rpm	rpm
32	RA3	5	66	120	150	150	200	1500	6000
		11	88	170	170	330	440		
		15	92	170	170	300	600		
		21	98	170	170				
		33	108	200	200	330	650		
45	108	200	200	300					
50	RA3	5	150	150	150	150	200	1500	4500
		11	170	330	330	330	440		
		15	200	400	450	450	600		
		21	200	450	500	630	840		
		33	230	470	500	990	1320		
	45	230	500	500	1140	1800			
	RA5	5	260	290	340	400	500	1300	4500
		11	260	340	400	880	1100		
		15	270	400	450	1200	1500		
		21	270	450	500	1150	2100		
33		270	470	500	1140	2180			
45	270	500	500						
65	RA5	5	400	400	400	400	500	1300	3000
		12	600	960	960	960	1200		
		15	730	1200	1200	1200	1500		
		20	800	1370	1500	1600	2000		
		25	850	1470	1500	2000	2500		
		40	640	1300	1300	1900	4000		
		50	750	1500	1500	2200	4500		

*1: Rated torque is based on life of 20,000 hours at max average input speed.

*2: Average load torque calculated based on the application motion profile must not exceed values shown in the table. See p. 60.

*3: The limit for torque during start and stop cycles. Always operate below this value.

*4: The limit for torque during emergency stops or from external shock loads.

*5: Max value of average input rotational speed during operation.

*6: Maximum instantaneous input speed.

Performance Table

Table 054-1

Size	Model	Ratio	Accuracy *1	Repeatability *2	Starting torque *3	Backdriving torque *4	No-load running torque *5
			arc min	arc sec	Ncm	Nm	Ncm
32	RA3	5	4	±15	64	3.3	179
		11			58	6.8	162
		15			56	8.9	155
		21			53	12	
		33			48	17	
		45			47	23	150
50	RA3	5	4	±15	111	5.8	241
		11			76	8.9	198
		15			71	11	173
		21			69	15	
		33			61	21	
		45			59	28	161
	RA5	5	3	±15	132	6.9	496
		11			97	11	459
		15			92	15	437
		21			90	20	
		33			82	29	
		45			80	38	427
65	RA5	5	3	±15	292	15	647
		12			177	23	532
		15			162	26	513
		20			147	31	494
		25			136	36	481
		40			127	51	460
		50			122	61	453

*1: Transmission accuracy values represent the difference between the theoretical angle and the actual angle of output for any given input. The values in the table are maximum values.

Figure 054-1

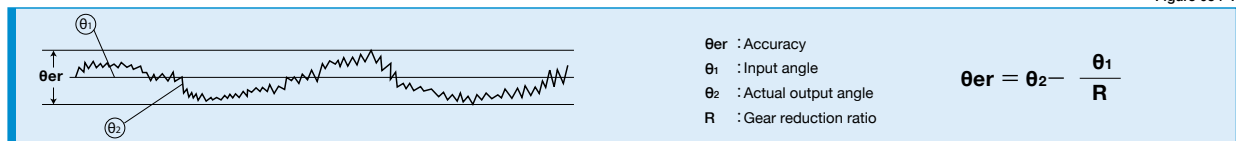

*2: The repeatability is measured by moving to a given theoretical position seven times, each time approaching from the same direction. The actual position of the output shaft is measured each time and repeatability is calculated as the 1/2 of the maximum difference of the seven data points. Measured values are indicated in angles (arc-sec) prefixed with "±". The values in the table are maximum values.

Figure 054-2

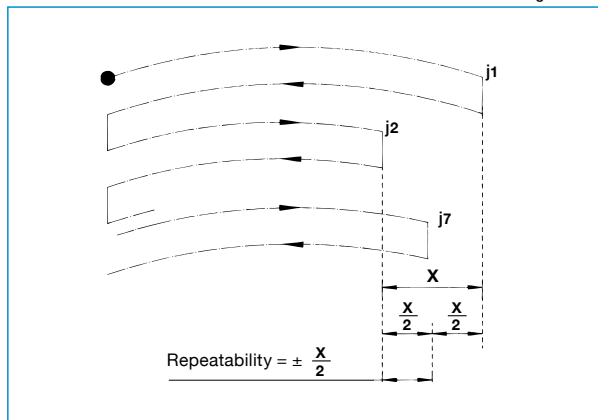

*3: Starting torque is the torque applied to the input side at which the output first starts to rotate. The values in the table are maximum values, and are based on 25° C.

*4: Backdriving torque is the torque value applied to the output side at which the input first starts to rotate. The values in the table are maximum values, and are based on 25° C.

Note: Never rely on these values as a margin in a system that must hold an external load. A brake must be used where back driving is not permissible.

*5: No-load running torque is the torque required at the input to operate the gearhead at a given speed under a no-load condition. The values in the table are average values, and are based on 25° C at 1,300 rpm for RA5 and 1500 rpm for RA3.

Backlash and Torsional Stiffness

Table 055-1

Right Angle					
Size	Model	Ratio	Backlash arc min	Torsion angle in one direction at $T_R \times 0.15$	Torsional stiffness
				D arc min	A/B Nm/arc min
32	RA3	5	3	1.9	21.56
		11			23.52
		15			24.5
		21			25.48
		33			26.46
50	RA3	5	3	2.7	38.22
		11		91.14	
		15		107.8	
		21		127.4	
		33		137.2	
	RA5	5	3	1.7	73.5
		11		117.6	
		15		127.4	
		21		137.2	
		33		147	
65	RA5	5	3	2.3	98
		12		254.8	
		15		284.2	
		20		313.6	
		25		333.2	
		40		352.8	
50	362.6				

Torsional stiffness curve

With the input of the gear locked in place, a torque applied to the output flange will torsionally deflect in proportion to the applied torque. We generate a torsional stiffness curve by slowly applying torque to the output in the following sequence:

(1) Clockwise torque to T_R , (2) Return to Zero, (3) Counter-Clockwise torque to $-T_R$, (4) Return to Zero and (5) again Clockwise torque to T_R .

A loop of (1) > (2) > (3) > (4) > (5) will be drawn as in Fig. 055-1.

The torsional stiffness in the region from " $0.15 \times T_R$ " to " T_R ," is calculated using the average value of this slope. The torsional stiffness in the region from "zero torque" to " $0.15 \times T_R$ " is lower. This is caused by the small amount of backlash plus engagement of the mating parts and loading of the planet gears under the initial torque applied.

Calculation of total torsion angle

The method to calculate the total torsion angle (average value) in one direction when a load is applied from no-load state.

Formula 055-1

● Calculation formula

$$\theta = D + \frac{T - T_L}{A/B}$$

Symbol	Description	Reference
θ	Total torsion angle	—
D	Torsion angle in one direction at output torque x 0.15 torque	See Fig. 055-1, Table 055-1
T	Load torque	—
T_L	Output torque x 0.15 torque ($=T_R \times 0.15$)	See Fig. 055-1
A/B	Torsional stiffness	See Fig. 055-1, Table 055-1

Backlash (Hysteresis loss)

The vertical distance between points (2) & (4) in Fig. 055-1 is called a hysteresis loss. The hysteresis loss between "Clockwise load torque T_R ," and "Counter Clockwise load torque $-T_R$," is defined as the backlash of the HPG series. Backlash of the HPG Right Angle series is less than 3 arc-min.

Figure 055-1

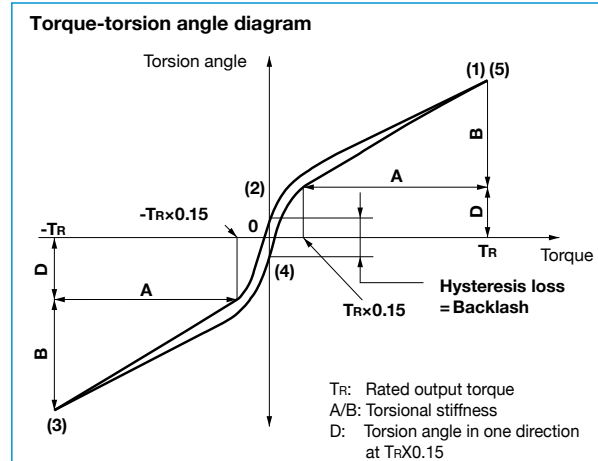

HPG-32RA Outline Dimensions

Only primary dimensions are shown in the drawings below. Refer to the confirmation drawing for detailed dimensions.

Figure 056-1

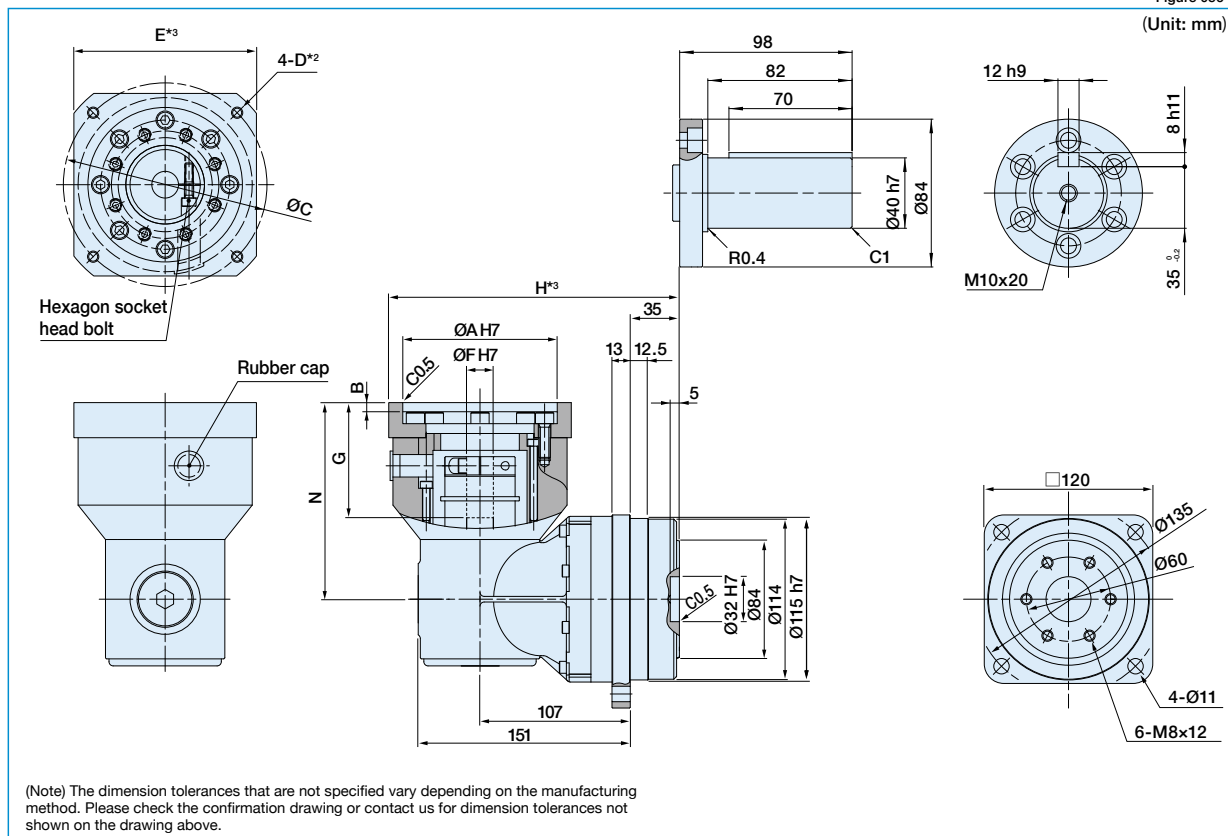

Dimension Table

(Unit: mm) Table 056-1

Flange	Coupling	A (H7)		B	C		F (H7)		G		N	Mass (kg) *1	
		Min.	Max.*2	Max.	Min.	Max.*2	Min.	Max.	Min.	Max.		Shaft	Flange
1	1	70	200	10	115	235	10	24	29	56	115	10.1	8.7
2	2	110	200	6.5	125	235	10	35	54	81	140	10.3	8.9

Refer to the confirmation drawing for detailed dimensions. Dimensions of typical products are shown. Please contact us for other mounting options if the configurations shown above are not suitable for your particular motor.

*1 The mass will vary slightly depending on the ratio and on the inside diameter of the input shaft coupling.

*2 Tapped hole for mounting screw.

*3 May vary depending on motor interface dimensions.

Moment of Inertia, Input Side

(10⁻⁴ kgm²) Table 056-2

HPG 32RA	Ratio		5	11	15	21	33	45
	Coupling							
	1		6.7	6.3	6.1	5.8	-	-
	2		8.09	7.62	-	-	-	-

HPG-50RA3 Outline Dimensions

Only primary dimensions are shown in the drawings below. Refer to the confirmation drawing for detailed dimensions.

Figure 057-1

(Unit: mm)

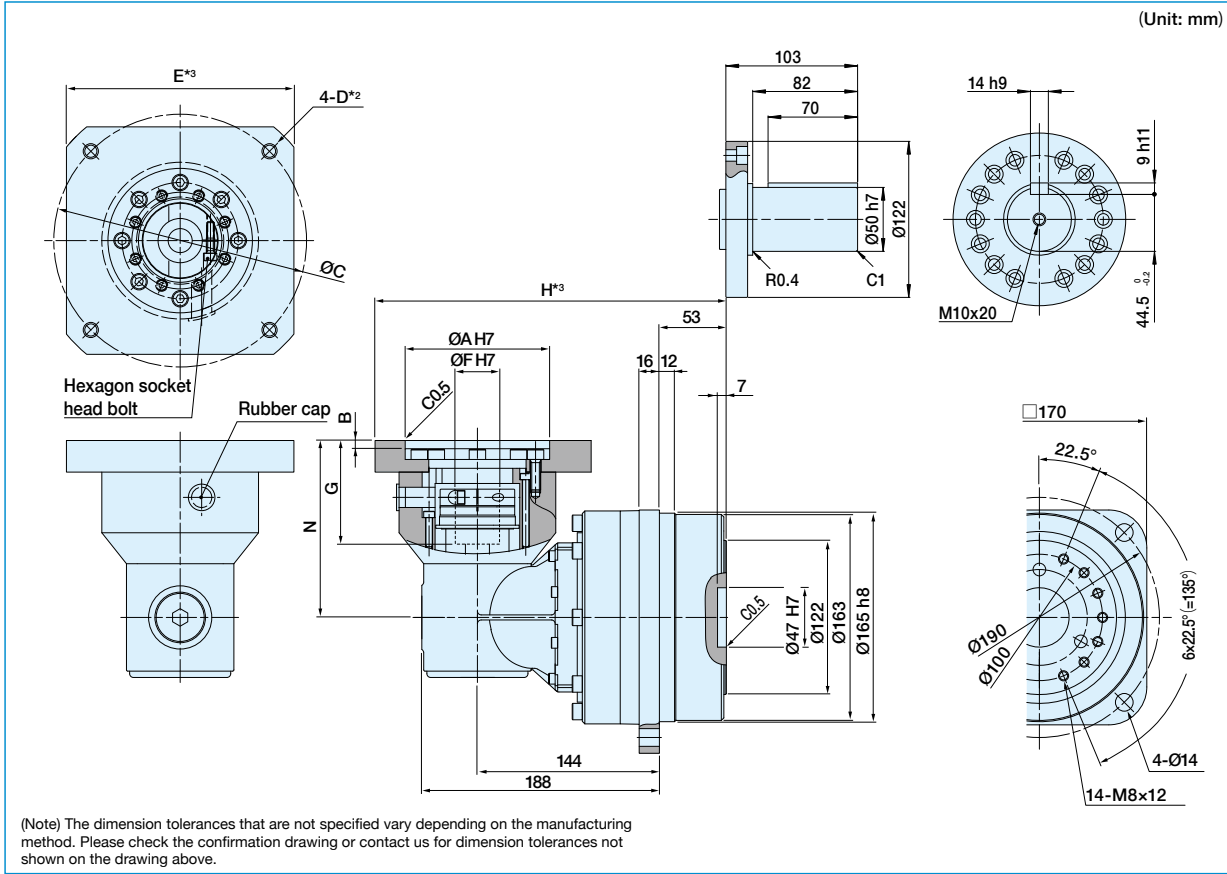

Dimension Table

(Unit: mm) Table 057-1

Flange	Coupling	A (H7)		B	C		F (H7)		G		N	Mass (kg) *1	
		Min.	Max.*3	Max.	Min.	Max.*4	Min.	Max.	Min.	Max.		Shaft	Flange
1	1	70	200	10	115	235	10	24	29	56	115	24	21
2	2	110	200	6.5	125	235	10	35	54	81	140	25	22

Refer to the confirmation drawing for detailed dimensions. Dimensions of typical products are shown. Please contact us for other mounting options if the configurations shown above are not suitable for your particular motor.

*1 The mass will vary slightly depending on the ratio and on the inside diameter of the input shaft coupling.

*2 Tapped hole for motor mounting screw.

*3 May vary depending on motor interface dimensions.

Moment of Inertia, Input Side

(10⁻⁴ kgm²) Table 057-2

HPG 50RA3	Coupling	Ratio	5	11	15	21	33	45
		1	-	9.4	8.8	7.5	6.4	6.4
2	-	10.8	10.2	8.9	7.8	7.73		

HPG-50RA5 Outline Dimensions

Only primary dimensions are shown in the drawings below. Refer to the confirmation drawing for detailed dimensions.

Figure 058-1

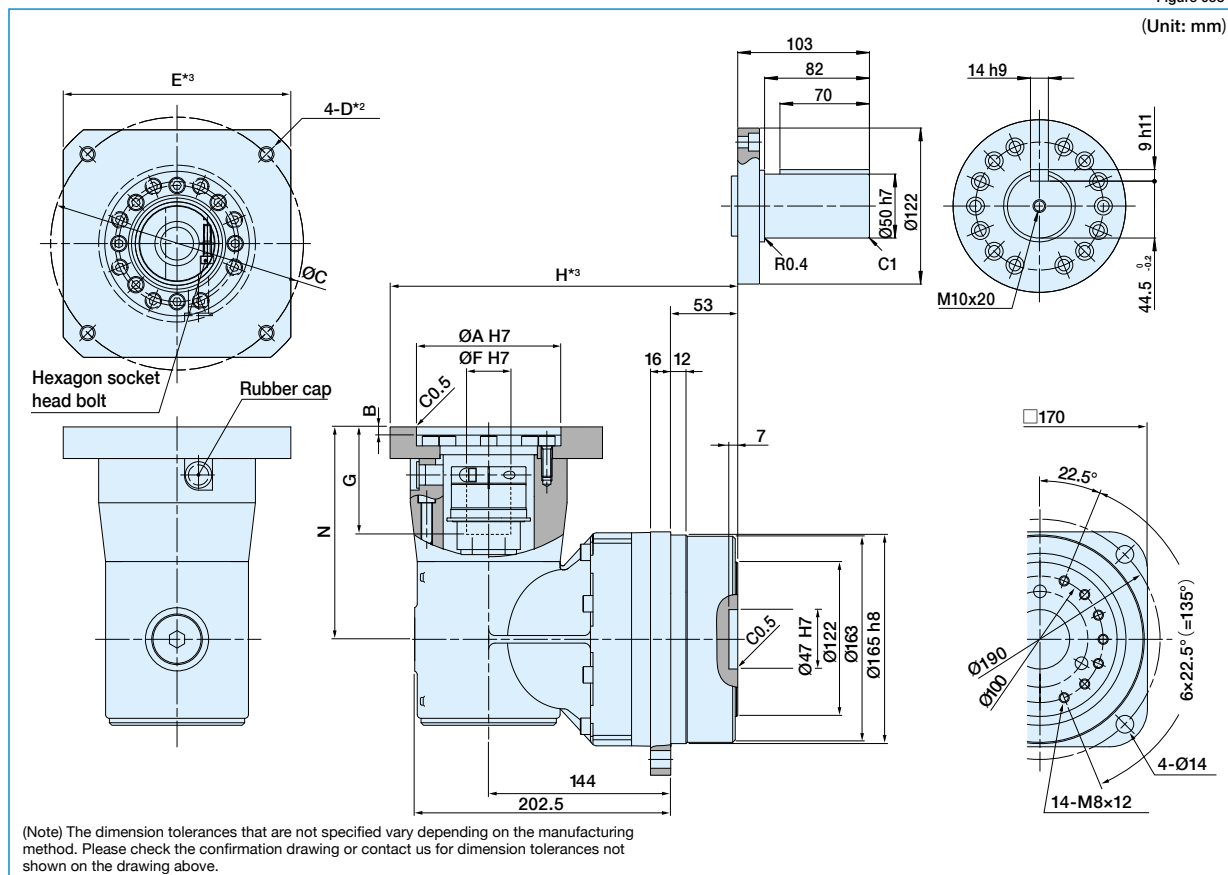

Dimension Table

(Unit: mm) Table 058-1

Flange	Coupling	A (H7)		B	C		F (H7)		G		N	Mass (kg) *1	
		Min.	Max.*3		Min.	Max.*4	Min.	Max.	Min.	Max.		Shaft	Flange
1	1	70	200	6.5	115	235	19	42	45	84	168	26.5	23.5
2	2	110	200	6.5	125	235	19	42	45	116	200	27.5	24.5

Refer to the confirmation drawing for detailed dimensions. Dimensions of typical products are shown. Please contact us for other mounting options if the configurations shown above are not suitable for your particular motor.

*1 The mass will vary slightly depending on the ratio and on the inside diameter of the input shaft coupling.

*2 Tapped hole for motor mounting screw.

*3 May vary depending on motor interface dimensions.

Moment of Inertia, Input Side

(10⁻⁴ kgm²) Table 058-2

HPG 50RA5	Ratio	5	11	15	21	33	45
	Coupling						
	1	37.4	33.9	33.3	32	-	-

HPG-65RA Outline Dimensions

Only primary dimensions are shown in the drawings below. Refer to the confirmation drawing for detailed dimensions.

Figure 059-1

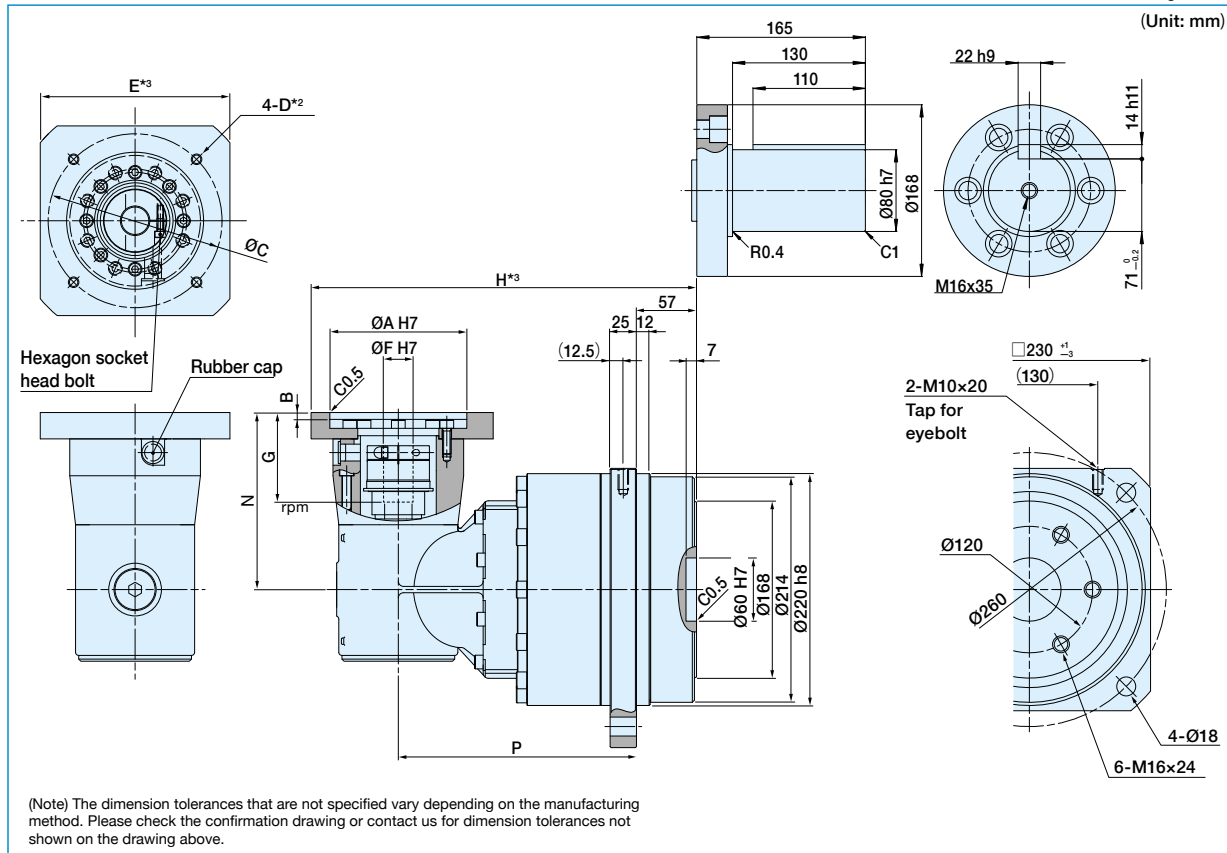

Dimension Table

(Unit: mm) Table 059-1

	Flange	Coupling	A (H7)		B	C		F (H7)		G		N	P	Mass (kg) *1	
			Min.	Max.*3		Max.	Min.	Max.*4	Min.	Max.	Min.			Max.	Shaft
Single Stage	1	1	70	200	6.5	115	235	19	42	45	84	168	172	49.5	39.5
	2	2	110	200	6.5	125	235	19	42	45	116	200	172	50.5	40.5
Two Stage	1	1	70	200	6.5	115	235	19	42	45	84	168	226	58.8	48.8
	2	2	110	200	6.5	125	235	19	42	45	116	200	226	59.8	49.8

Refer to the confirmation drawing for detailed dimensions. Dimensions of typical products are shown. Please contact us for other mounting options if the configurations shown above are not suitable for your particular motor.

*1 The mass will vary slightly depending on the ratio and on the inside diameter of the input shaft coupling.

*2 Tapped hole for motor mounting screw.

*3 May vary depending on motor interface dimensions.

Moment of Inertia, Input Side

(10⁻⁴ kgm²) Table 059-2

HPG 65RA	Coupling	Ratio		5	12	15	20	25	40	50
		1	2							
	1	-	-	48.8	47.8	37.9	37.3	32.3	32.1	-
	2	60.6	49.2	48.2	38.3	37.7	-	-	-	-

Sizing & Selection

To fully utilize the excellent performance of the HPG-RA HarmonicPlanetary® gearheads, check your operating conditions and, using the flowchart, select the appropriate size gear for your application.

Check your operating conditions against the following application motion profile and select a suitable size based on the flowchart shown on the right. Also check the life and static safety coefficient of the cross roller bearing.

Application motion profile

Review the application motion profile. Check the specifications shown in the figure below.

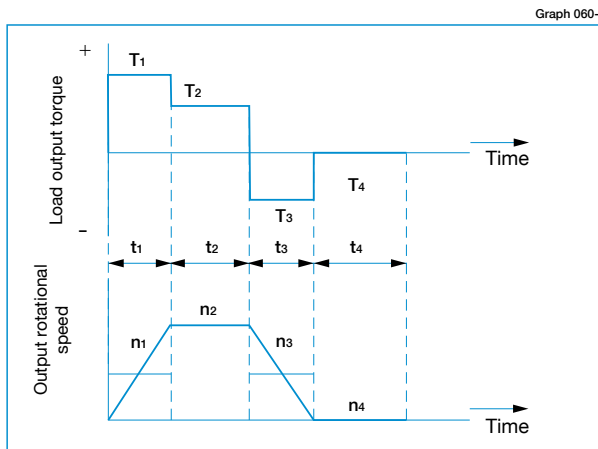

Obtain the value of each application motion profile

Load torque	T ₁ to T _n (Nm)
Time	t ₁ to t _n (sec)
Output rotational speed	n ₁ to n _n (rpm)

Normal operation pattern

Starting (acceleration)	T ₁ , t ₁ , n ₁
Steady operation (constant velocity)	T ₂ , t ₂ , n ₂
Stopping (deceleration)	T ₃ , t ₃ , n ₃
Dwell	T ₄ , t ₄ , n ₄

Maximum rotational speed

Max. output rotational speed	n _{o max} ≥ n ₁ to n _n
Max. input rotational speed (Restricted by motors)	n _{i max} n ₁ × R to n _n × R
	R: Reduction ratio

Impact torque

When impact torque is applied	T _s
-------------------------------	----------------

Required life

$$L_{50} = L \text{ (hours)}$$

Flowchart for selecting a size

Please use the flowchart shown below for selecting a size. Operating conditions must not exceed the performance ratings.

Calculate the average load torque applied on the output side from the application motion profile: T_{av} (Nm).

$$T_{av} = \sqrt[10/3]{\frac{|n_1| \cdot t_1 \cdot |T_1|^{10/3} + |n_2| \cdot t_2 \cdot |T_2|^{10/3} + \dots + |n_n| \cdot t_n \cdot |T_n|^{10/3}}{|n_1| \cdot t_1 + |n_2| \cdot t_2 + \dots + |n_n| \cdot t_n}}$$

Calculate the average output speed based on the application motion profile: n_{o av} (rpm)

$$n_{o av} = \frac{|n_1| \cdot t_1 + |n_2| \cdot t_2 + \dots + |n_n| \cdot t_n}{t_1 + t_2 + \dots + t_n}$$

Make a preliminary model selection with the following condition: T_{av} ≤ Average load torque (Refer to rating table).

OK

Determine the reduction ratio (R) based on the maximum output rotational speed (n_{o max}) and maximum input rotational speed (n_{i max}).

$$\frac{n_{i max}}{n_{o max}} \geq R$$

(A limit is placed on n_{i max} by motors.)

Calculate the maximum input speed (n_{i max}) from the maximum output speed (n_{o max}) and the reduction ratio (R).

$$n_{i max} = n_{o max} \cdot R$$

Calculate the average input speed (n_{i av}) from the average output speed (n_{o av}) and the reduction ratio (R): n_{i av} = n_{o av} × R ≤ Max. average input speed (n_r).

OK

Check whether the maximum input speed is equal to or less than the values in the rating table. n_{i max} ≤ maximum input speed (rpm)

OK

Check whether T₁ and T₃ are within peak torques (Nm) at start and stop in the rating table.

OK

Check whether T_s is less than the momentary max. torque (Nm) value from the ratings.

OK

Calculate the life and check whether it meets the specification requirement.

T_r: Rated torque

n_r: Max. average input speed

$$L_{50} = 20,000 \cdot \left(\frac{T_r}{T_{av}}\right)^{10/3} \cdot \left(\frac{n_r}{n_{i av}}\right) \text{ (Hour)}$$

OK

The model number is confirmed.

Refer to the Caution note below.

Review the operation conditions, size and reduction ratio.

Caution

If any of the following conditions exist, please consider selecting the next larger speed reducer, reduce the operating loads or reduce the operating speed. If this cannot be done, please contact Harmonic Drive LLC. Exercise caution especially when the duty cycle is close to continuous operation.

- i) Actual average load torque (T_{av}) > Permissible maximum value of average load torque or
- ii) Actual average input rotational speed (n_{i av}) > Permissible average input rotational speed (n_r),
- iii) Gearhead housing temperature > 70°C

Example of model number Selection

Load torque T_n (Nm)
 Time t_n (sec)
 Output rotational speed n_n (rpm)

Normal operation pattern

Starting (acceleration) $T_1 = 70$ Nm, $t_1 = 0.3$ sec, $n_1 = 60$ rpm
 Steady operation (constant velocity) $T_2 = 18$ Nm, $t_2 = 3$ sec, $n_2 = 120$ rpm
 Stopping (deceleration) $T_3 = 35$ Nm, $t_3 = 0.4$ sec, $n_3 = 60$ rpm
 Dwell $T_4 = 0$ Nm, $t_4 = 5$ sec, $n_4 = 0$ rpm

Maximum rotational speed

Max. output rotational speed $n_o \max = 120$ rpm
 Max. input rotational speed $n_i \max = 5,000$ rpm
 (Restricted by motors)

Emergency stop torque

When impact torque is applied $T_s = 180$ Nm

Required life

$L_{50} = 30,000$ (hours)

Calculate the average load torque applied to the output side based on the application motion profile: T_{av} (Nm).

$$T_{av} = \sqrt[10/3]{\frac{|60\text{rpm}| \cdot 0.3\text{sec} \cdot |70\text{Nm}|^{10/3} + |120\text{rpm}| \cdot 3\text{sec} \cdot |18\text{Nm}|^{10/3} + |60\text{rpm}| \cdot 0.4\text{sec} \cdot |35\text{Nm}|^{10/3}}{|60\text{rpm}| \cdot 0.3\text{sec} + |120\text{rpm}| \cdot 3\text{sec} + |60\text{rpm}| \cdot 0.4\text{sec}}}$$

Calculate the average output speed based on the application motion profile: n_{av} (rpm)

$$n_{av} = \frac{|60\text{rpm}| \cdot 0.3\text{sec} + |120\text{rpm}| \cdot 3\text{sec} + |60\text{rpm}| \cdot 0.4\text{sec} + |0\text{rpm}| \cdot 5\text{sec}}{0.3\text{sec} + 3\text{sec} + 0.4\text{sec} + 5\text{sec}}$$

Make a preliminary model selection with the following conditions. $T_{av} = 30.2$ Nm ≤ 120 Nm. (HPG-32A-5-RA3 is tentatively selected based on the average load torque (see the rating table) of size 32 and reduction ratio of 5.)

OK

Determine a reduction ratio (R) from the maximum output speed ($n_o \max$) and maximum input speed ($n_i \max$).

$$\frac{5,000 \text{ rpm}}{120 \text{ rpm}} = 41.7 \geq 5$$

Calculate the maximum input speed ($n_i \max$) from the maximum output speed ($n_o \max$) and reduction ratio (R): $n_i \max = 120 \text{ rpm} \cdot 5 = 600 \text{ rpm}$

Calculate the average input speed (n_{iav}) from the average output speed (n_{av}) and reduction ratio (R):
 $n_{iav} = 46.2 \text{ rpm} \cdot 5 = 1,525 \text{ rpm} \leq \text{Max average input speed of size 32 } 1,500 \text{ rpm}$

OK

Check whether the maximum input speed is equal to or less than the values specified in the rating table.
 $n_i \max = 3,960 \text{ rpm} \leq 600 \text{ rpm}$ (maximum input speed of size 32)

OK

Check whether T_1 and T_3 are within peak torques (Nm) on start and stop in the rating table.

$T_1 = 70 \text{ Nm} \leq 120 \text{ Nm}$ (Limit for repeated peak torque, size 32)
 $T_3 = 35 \text{ Nm} \leq 120 \text{ Nm}$ (Limit for repeated peak torque, size 32)

OK

Check whether T_s is less than limit for momentary torque (Nm) in the rating table.
 $T_s = 180 \text{ Nm} \leq 200 \text{ Nm}$ (momentary max. torque of size 32)

OK

Calculate life and check whether the calculated life meets the requirement.

$$L_{50} = 20,000 \cdot \left(\frac{120 \text{ Nm}}{30.2 \text{ Nm}}\right)^{10/3} \cdot \left(\frac{3,000 \text{ rpm}}{231 \text{ rpm}}\right) = 25,932,572 \text{ (hours)} \geq 30,000 \text{ (hours)}$$

OK

The selection of model number HPG-32A-5-RA3 is confirmed from the above calculations.

Refer to the Caution note at the bottom of page 60.

Review the operation conditions, size and reduction ratio.

Harmonic Planetary[®] HPGP / HPG Series

Harmonic Drive's expertise in the field of elasto-mechanics of metals is applied to the internal gear of the HPG, HPGP and HPF Series to provide the gearhead with continuous backlash compensation. Planetary gears have simultaneous meshing between the sun gear, planet gears, and the internal ring gear. Most manufacturers try to reduce the backlash by controlling the dimensional precision of the parts. However this causes interference of meshing parts due to dimensional errors, resulting in uneven input torque, vibration, higher noise and premature wear (increase in backlash).

Harmonic Planetary[®] gears use a precision engineered elastic ring gear which compensates for interference between meshing parts. This proprietary Harmonic Planetary[®] gear design provides smooth and quiet motion and maintains ultra-low backlash for the life of the reducer.

- ◆ **Low backlash: Less than 3 arc-min (Less than 1 arc-min also available)**
- ◆ **Low gear ratios, 3:1 to 50:1**
- ◆ **High efficiency**
- ◆ **High load capacity by integrating structure with cross roller bearing**
- ◆ **High-torque capacity**

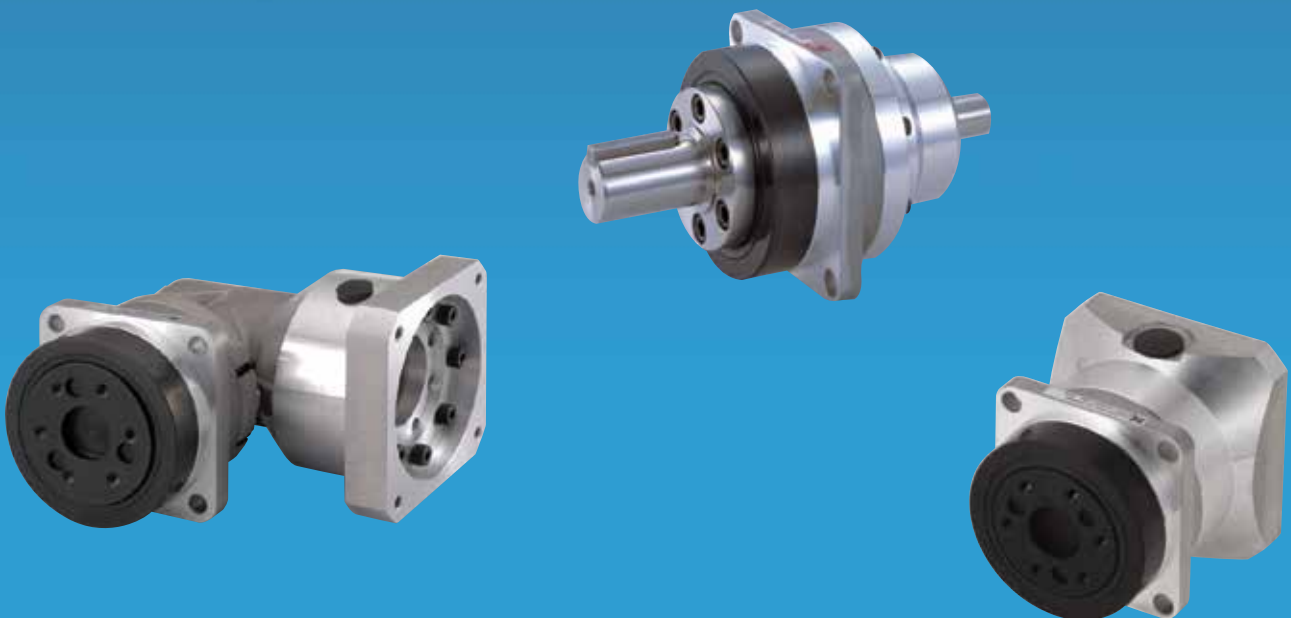

Robust cross roller bearing and output flange are integrated to provide high moment stiffness, high load capacity and precise positioning accuracy.

The cross roller bearing output flange serves as the second stage carrier for a rugged, compact design.

Backlash compensating internal gear

Shielded or sealed input bearing

Motor mounting flange

Quick Connect® coupling for easy mounting of any servomotor

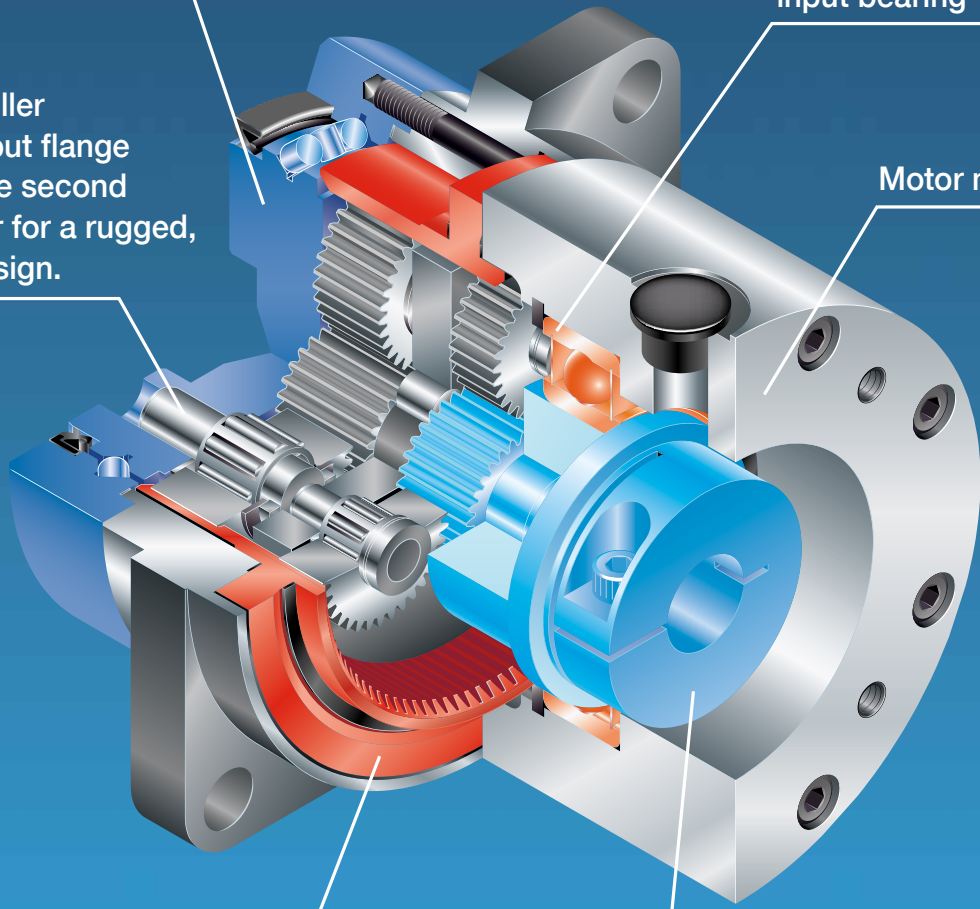



Harmonic Planetary®

Harmonic Drive®

Technical Information

Efficiency	122
Output Bearing Specifications and Checking Procedure	141
Input Bearing Specifications and Checking Procedure	145

Product Handling

Assembly	147
Mechanical Tolerances	150
Lubrication	151
Warranty, Disposal	153
Safety	154

The rated value and performance vary depending on the product series.
Be sure to check the usage conditions and refer to the items conforming
to the related product.

Efficiency

In general, the efficiency of a speed reducer depends on the reduction ratio, input rotational speed, load torque, temperature and lubrication condition. The efficiency of each series under the following measurement conditions is plotted in the graphs on the next page. The values in the graph are average values.

Measurement condition

Table 122-1

Input rotational speed	HPGP / HPG / HPF / HPN: 3000rpm CSG-GH / CSF-GH: Indicated on each efficiency graph.
Ambient temperature	25°C
Lubricant	Use standard lubricant for each model. (See pages 151- 152 for details.)

Efficiency compensated for low temperature

Calculate the efficiency at an ambient temperature of 25°C or less by multiplying the efficiency at 25°C by the low-temperature efficiency correction value. Obtain values corresponding to an ambient temperature and to an input torque (TRi*) from the following graphs when calculating the low-temperature efficiency correction value.

HPGP

HPG

HPF

HPN

* TRi is an input torque corresponding to output torque at 25°C.

Graph 122-1

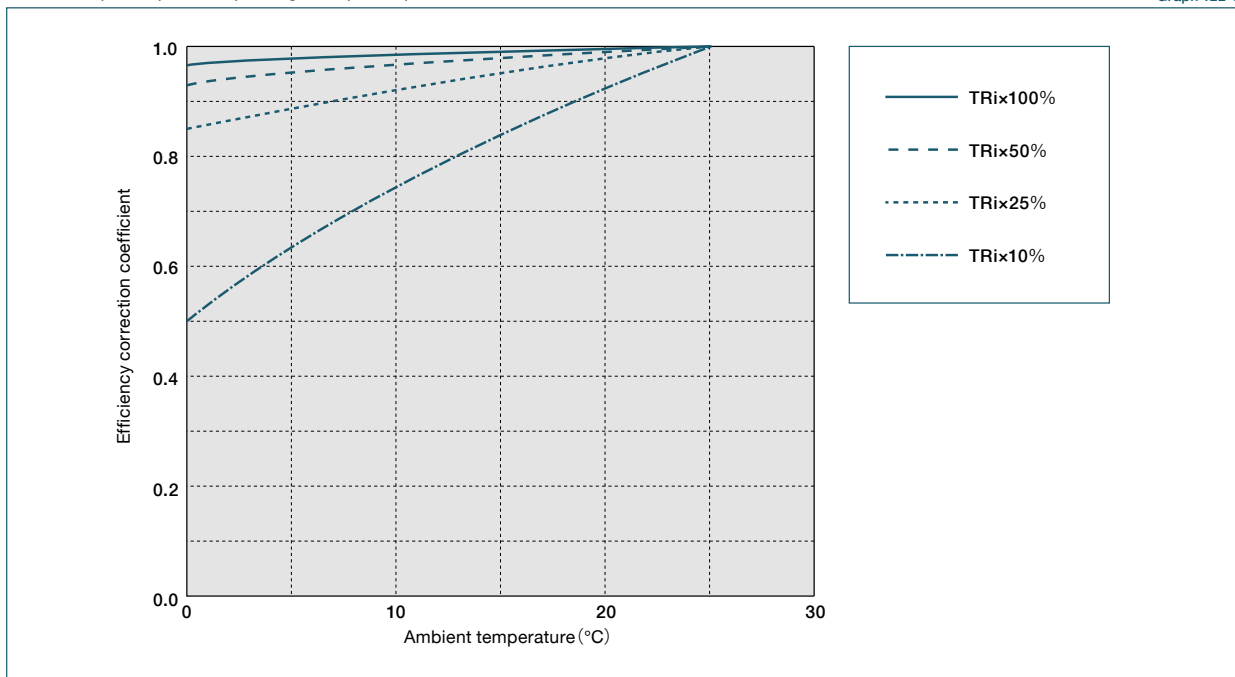

CSG-GH

CSF-GH

* TRi is an input torque corresponding to output torque at 25°C.

Graph 122-2

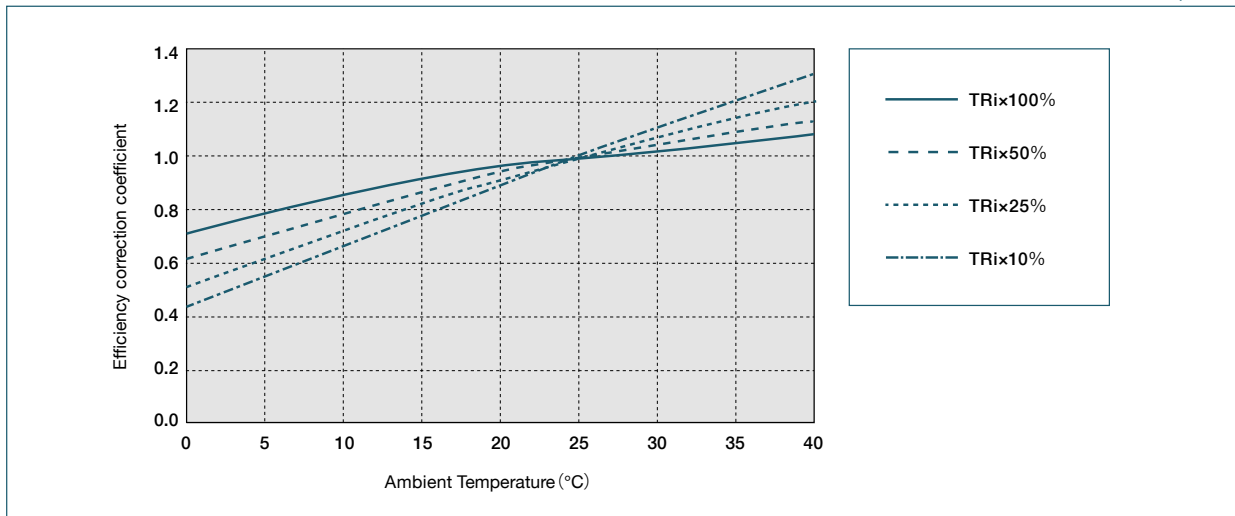

Size 11 : Gearhead

HPGP

Reduction Ratio = 5

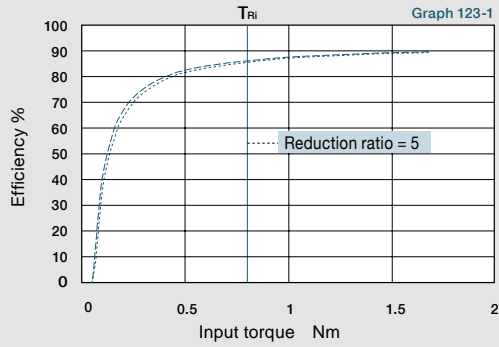

Reduction Ratio = 21

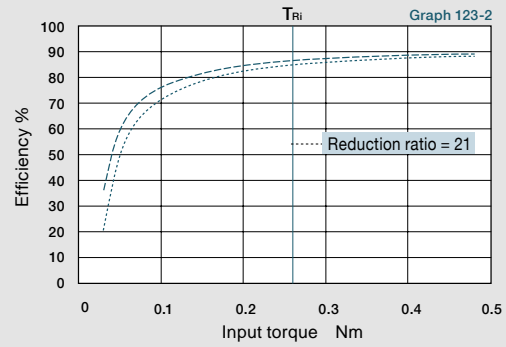

Reduction Ratio = 37, 45

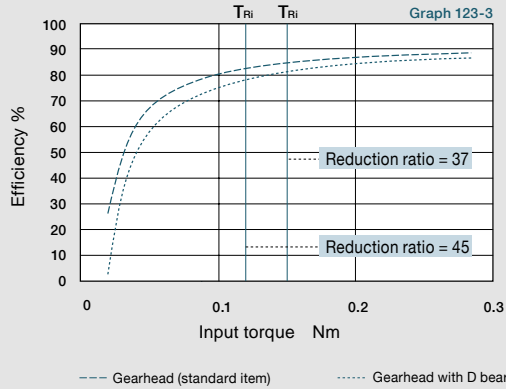

--- Gearhead (standard item) - - - - Gearhead with D bearing (double sealed) T_{Ri} Input torque corresponding to output torque

Size 14 : Gearhead

HPGP

Reduction Ratio = 5

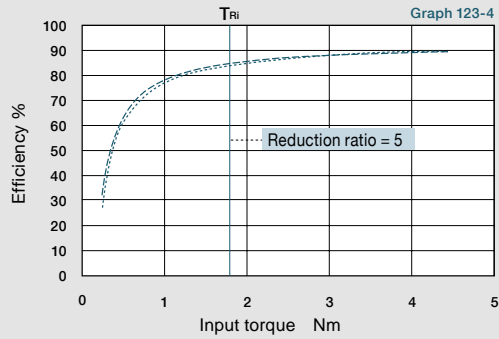

Reduction Ratio = 11

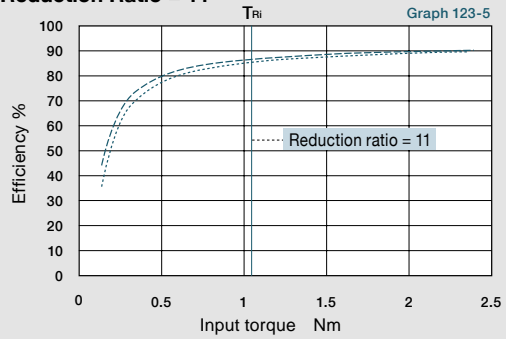

Reduction Ratio = 15, 21

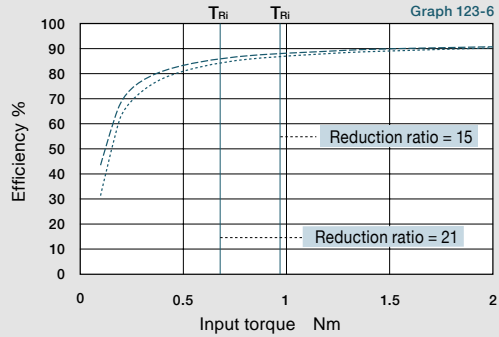

Reduction Ratio = 33, 45

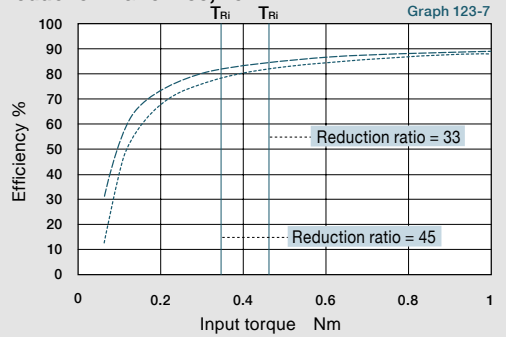

--- Gearhead (standard item) - - - - Gearhead with D bearing (double sealed) T_{Ri} Input torque corresponding to output torque

Size 20 : Gearhead

HPGP

Reduction ratio = 5

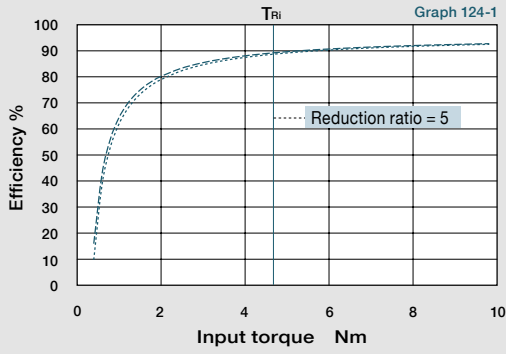

Reduction ratio = 11

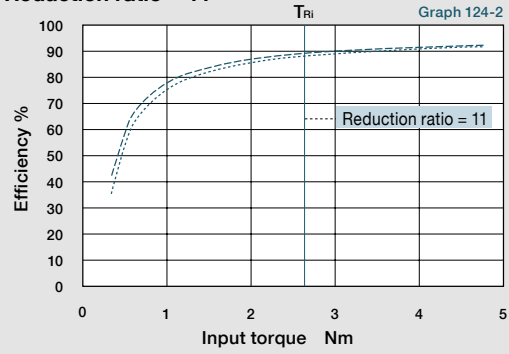

Reduction ratio = 15, 21

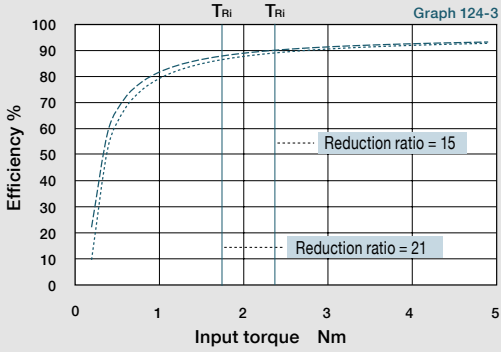

Reduction ratio = 33, 45

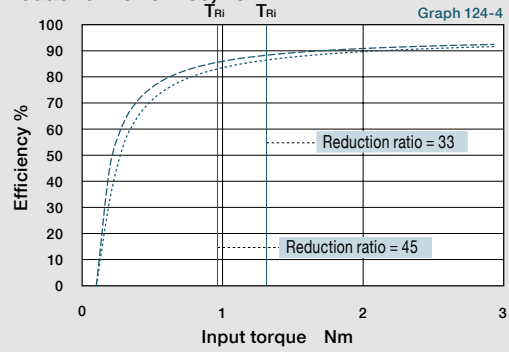

--- Gearhead (standard item)

----- Gearhead with D bearing (double sealed)

T_{Ri} Input torque corresponding to output torque

Size 32 : Gearhead

HPGP

Reduction ratio = 5 *1

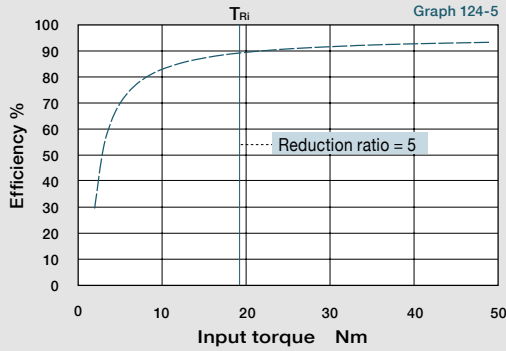

Reduction ratio = 11

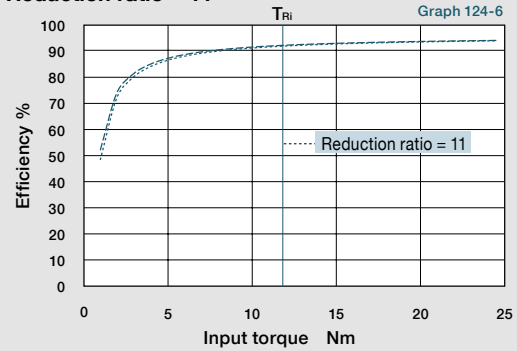

Reduction ratio = 15, 21

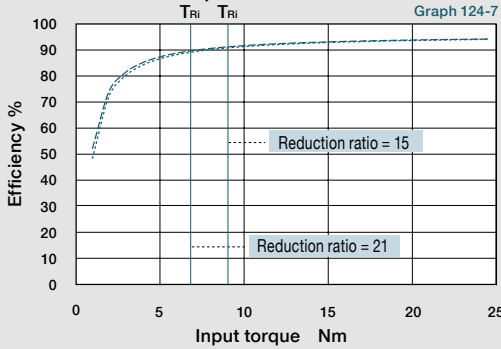

Reduction ratio = 33, 45

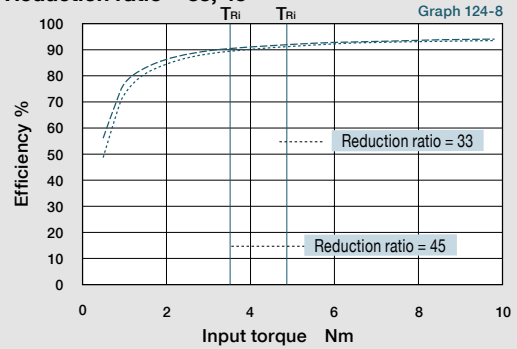

--- Gearhead (standard item)

----- Gearhead with D bearing (double sealed)

T_{Ri} Input torque corresponding to output torque

*1 Only one line is shown because the difference between the gearhead and a bearing assembled on the input side is small.

Size 50 : Gearhead

HPGP

Reduction ratio = 5 *²

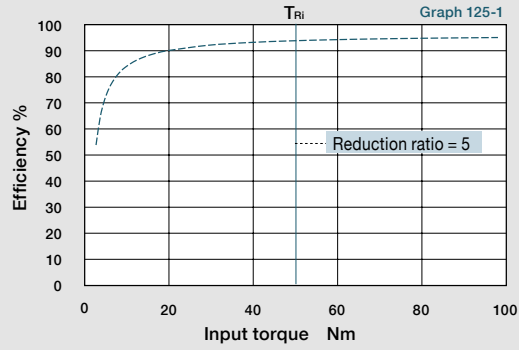

Reduction ratio = 11 *²

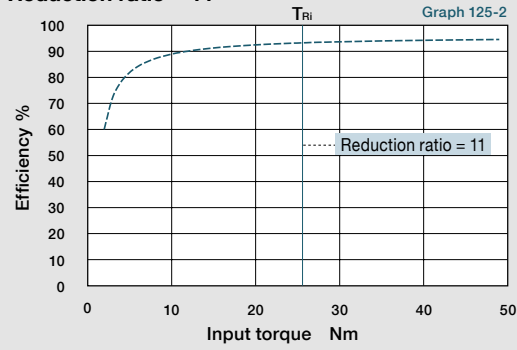

Reduction ratio = 15, 21 *²

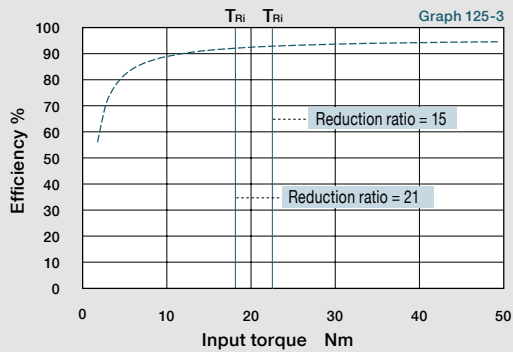

Reduction ratio = 33, 45

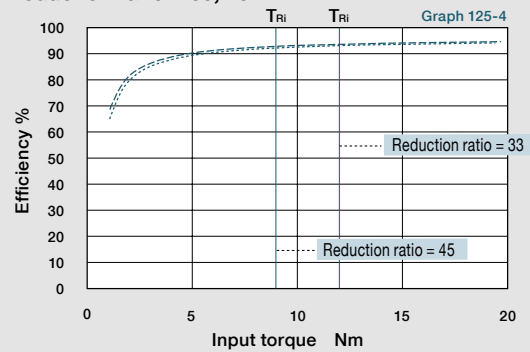

--- Gearhead (standard item) Gearhead with D bearing (double sealed) T_{Ri} Input torque corresponding to output torque

*² Only one line is shown because the difference between the gearhead and a bearing assembled on the input side is small.

Size 65 : Gearhead

HPGP

Reduction ratio = 4, 5 *³

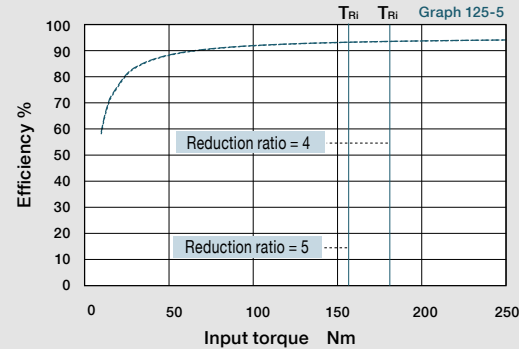

Reduction ratio = 12 *³

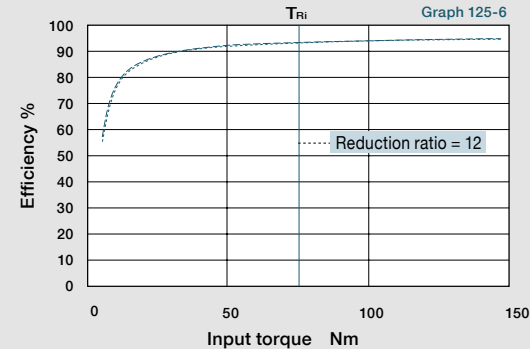

Reduction ratio = 15, 20 *³

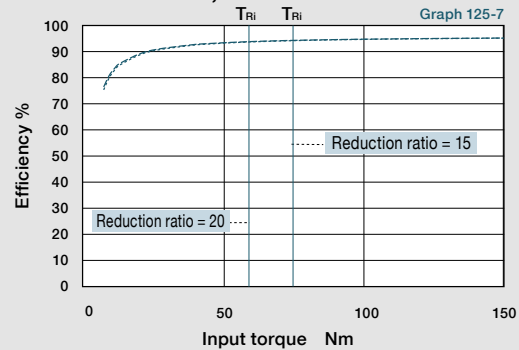

Reduction ratio = 25 *³

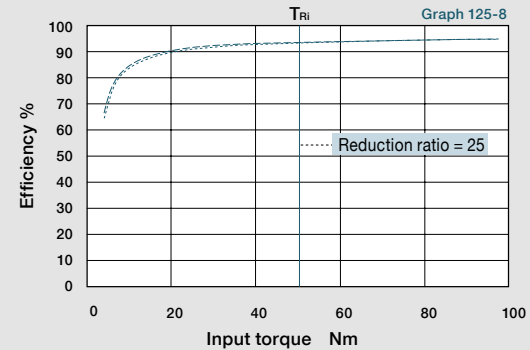

--- Gearhead (standard item) Gearhead with D bearing (double sealed) T_{Ri} Input torque corresponding to output torque

*³ Only one line is shown because the difference between the gearhead and a bearing assembled on the input side is small.

Size 11 : Gearhead & Input Shaft Unit

HPG

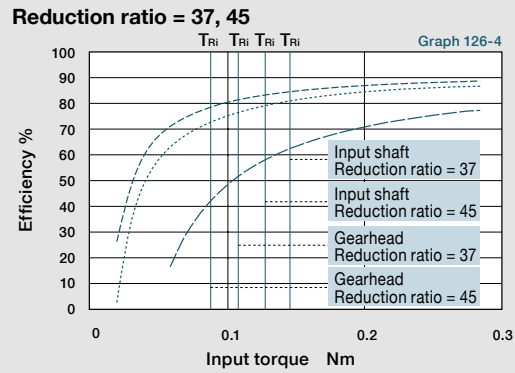
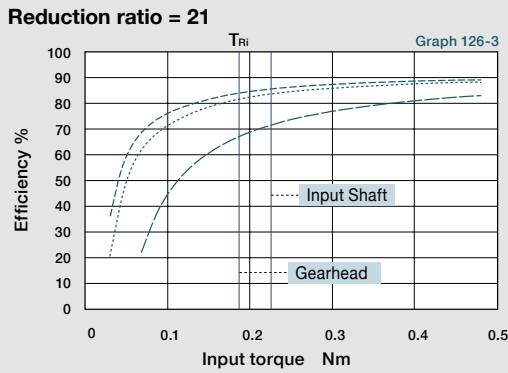
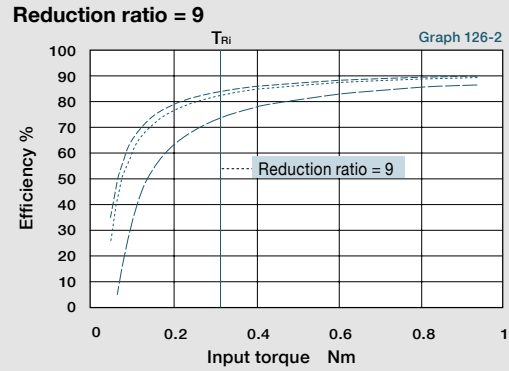
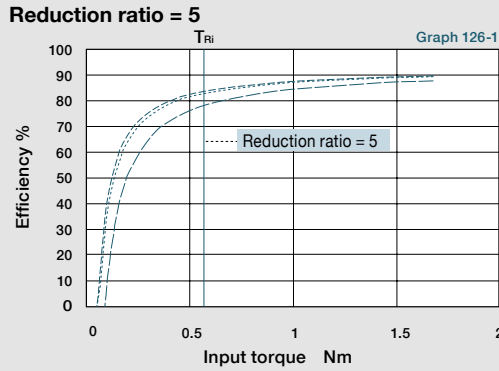

--- Gearhead (standard item) - - - - Gearhead with D bearing (double sealed)

T_{Ri} Input torque corresponding to output torque

Size 14 : Gearhead & Input Shaft Unit

HPG

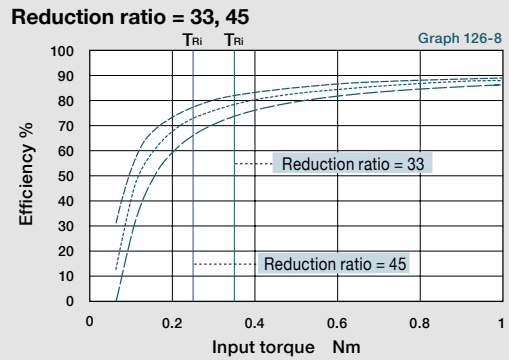
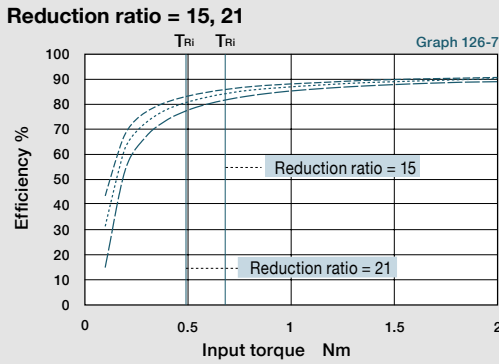
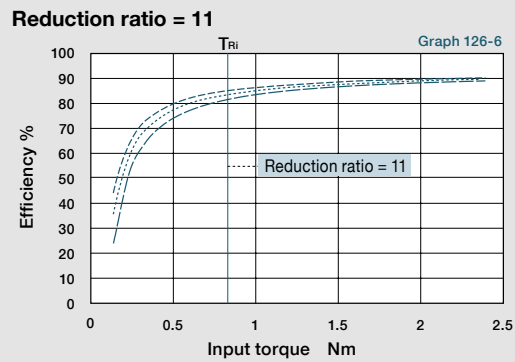
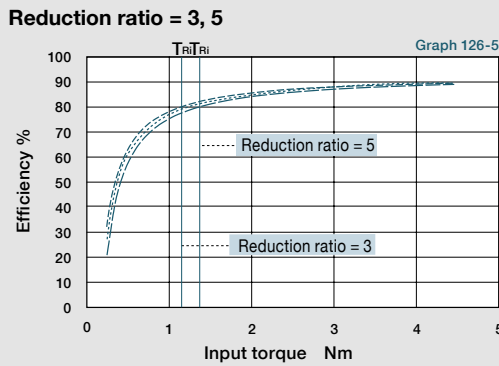

--- Gearhead (standard item) - - - - Gearhead with D bearing (double sealed)

T_{Ri} Input torque corresponding to output torque

Size 20 : Gearhead & Input Shaft Unit

HPG

Reduction ratio = 3, 5

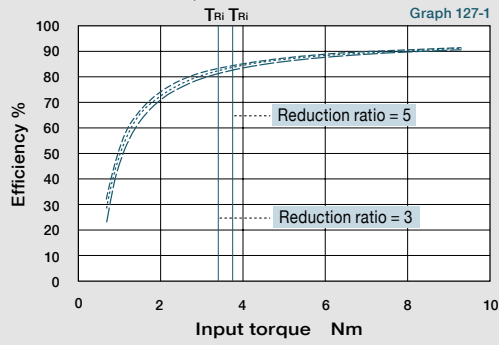

Reduction ratio = 11

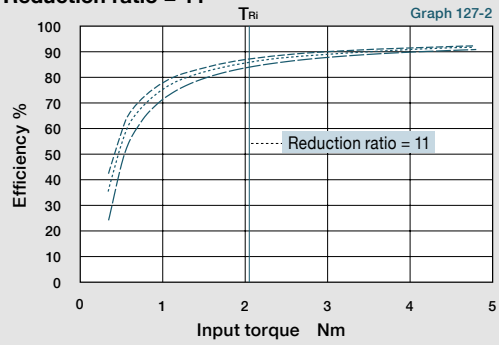

Reduction ratio = 15, 21

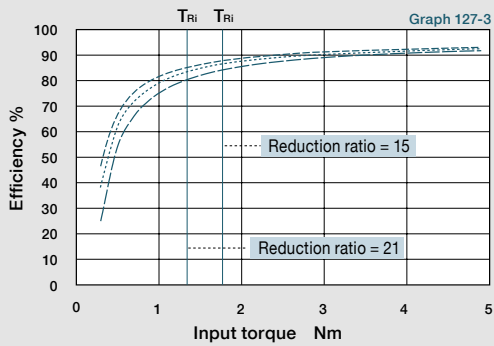

Reduction ratio = 33, 45

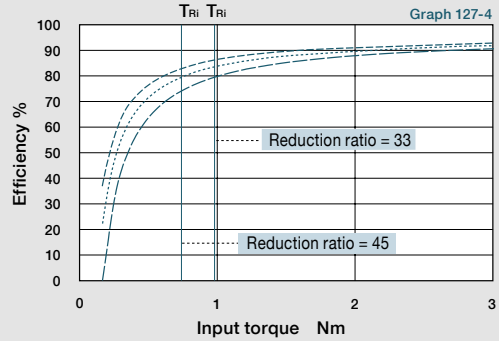

--- Gearhead (standard item) - - - - Gearhead with D bearing (double sealed) — Input Shaft T_{Ri} Input torque corresponding to output torque

Size 32 : Gearhead & Input Shaft Unit

HPG

Reduction ratio = 3, 5*1

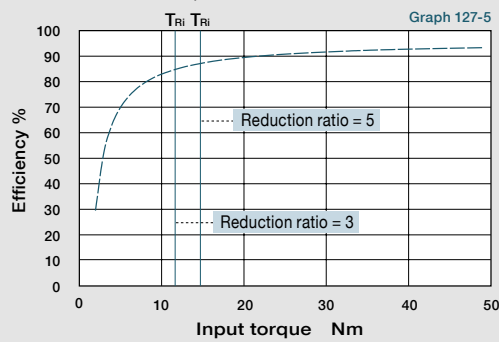

Reduction ratio = 11

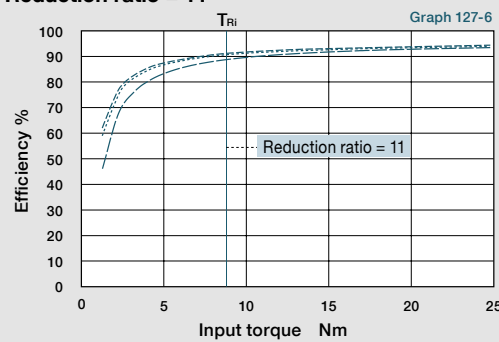

Reduction ratio = 15, 21

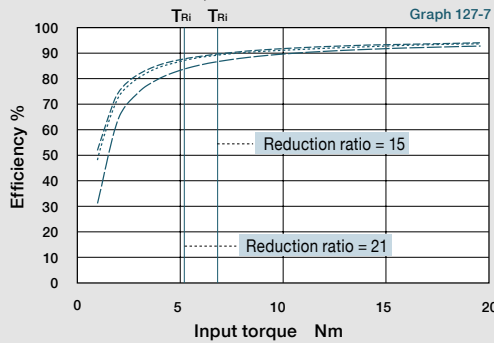

Reduction ratio = 33, 45

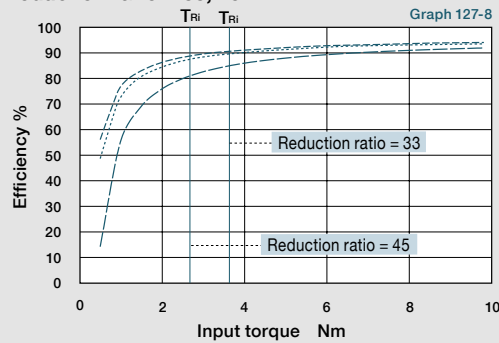

--- Gearhead (standard item) - - - - Gearhead with D bearing (double sealed) — Input Shaft T_{Ri} Input torque corresponding to output torque

*1 Only one line is shown because the difference between the gearhead and a bearing assembled on the input side is small.

Size 50 : Gearhead & Input Shaft Unit

HPG

Reduction ratio = 3, 5*2

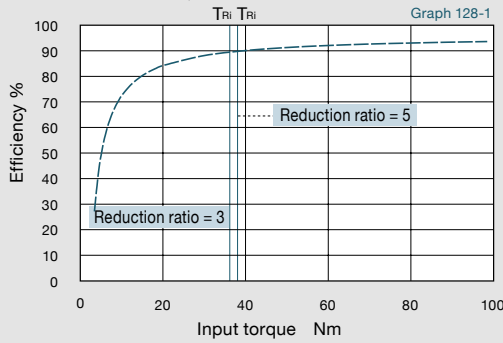

Reduction ratio = 11*2

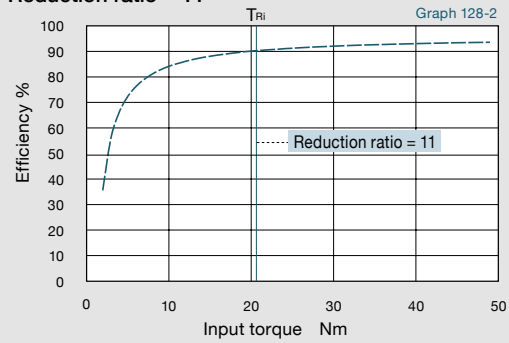

Reduction ratio = 15, 21*2

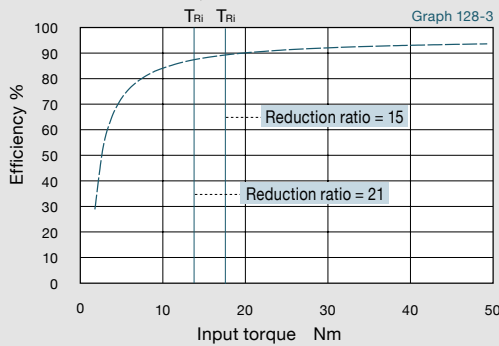

Reduction ratio = 33, 45

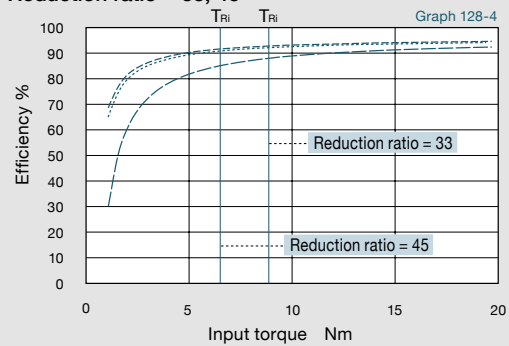

--- Gearhead (standard item) - - - - Gearhead with D bearing (double sealed) — Input Shaft T_{Ri} Input torque corresponding to output torque

*2 Only one line is shown because the difference between the gearhead and a bearing assembled on the input side is small.

Size 65 : Gearhead & Input Shaft Unit

HPG

Reduction ratio = 4, 5*3

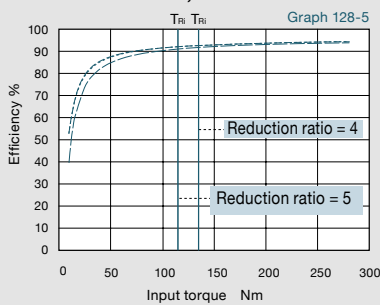

Reduction ratio = 12

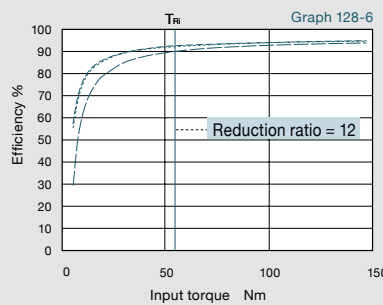

Reduction ratio = 15, 20

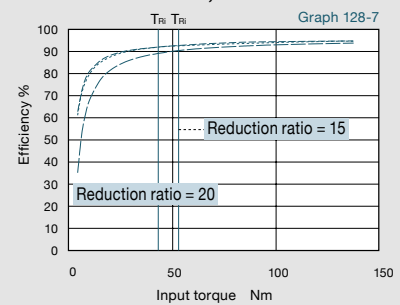

Reduction ratio = 25

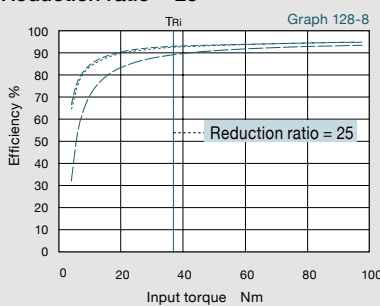

Reduction ratio = 40*3

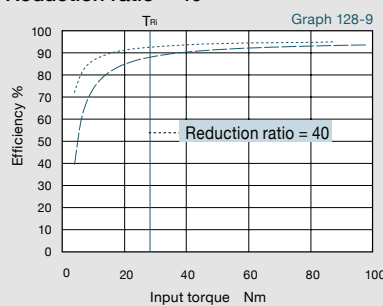

Reduction ratio = 50

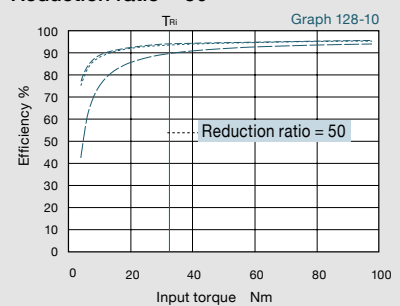

--- Gearhead (standard item) - - - - Gearhead with D bearing (double sealed) — Input Shaft T_{Ri} Input torque corresponding to output torque

*3 Only one line is shown because the difference between the gearhead and a bearing assembled on the input side is small.

Size 11

: Gearhead

HPG-Helical

Reduction ratio = 4

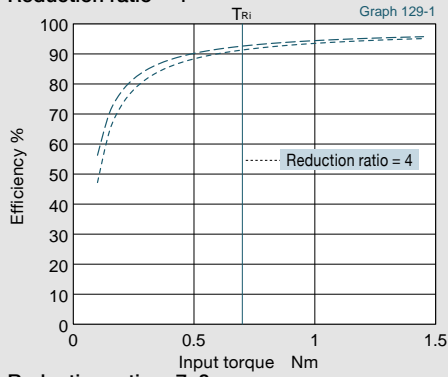

Reduction ratio = 5, 6

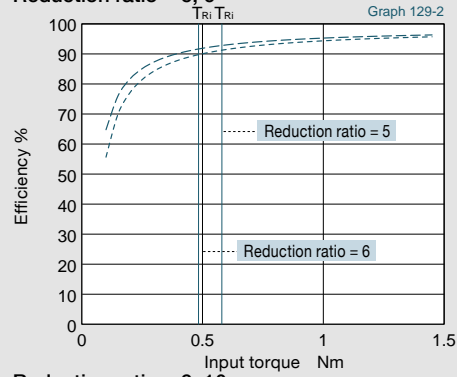

Reduction ratio = 7, 8

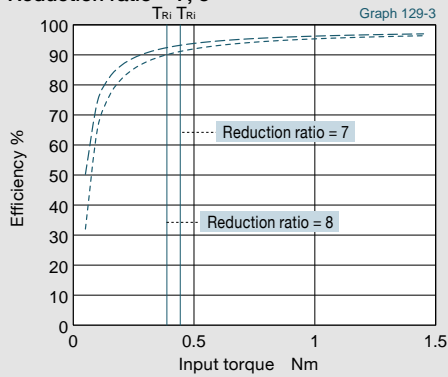

Reduction ratio = 9, 10

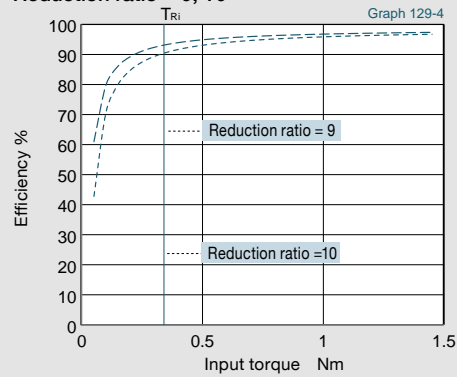

--- Gearhead with Z bearing (Double shielded)

..... Gearhead with D bearing (double sealed)

T_{Ri} Input torque corresponding to output torque

Size 14

: Gearhead

HPG-Helical

Reduction ratio = 3, 4

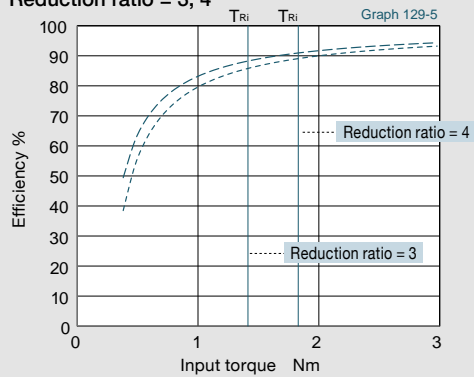

Reduction ratio = 5, 6

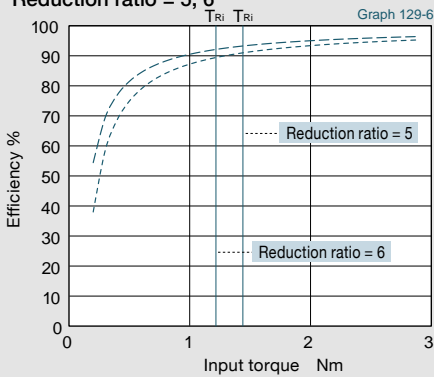

Reduction ratio = 7, 8

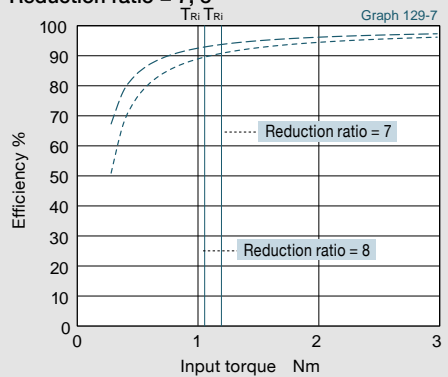

Reduction ratio = 9, 10

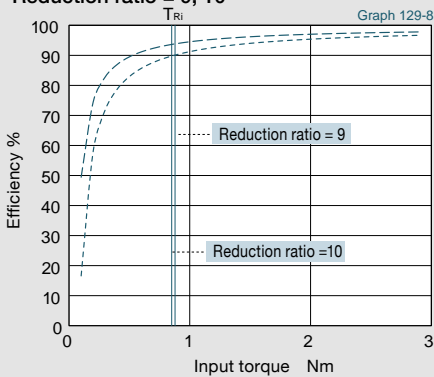

--- Gearhead with Z bearing (Double shielded)

..... Gearhead with D bearing (double sealed)

T_{Ri} Input torque corresponding to output torque

Size 20 : Gearhead

HPG-Helical

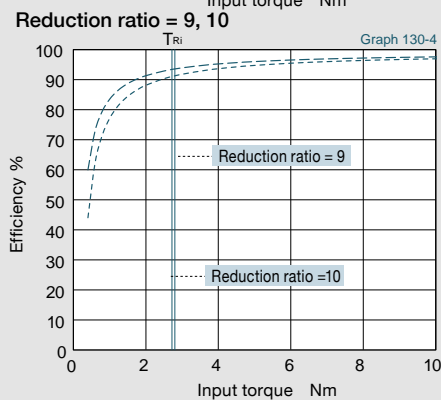
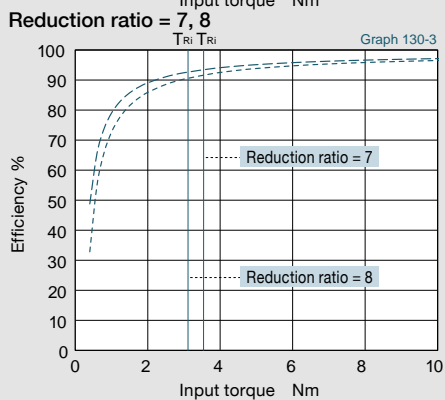
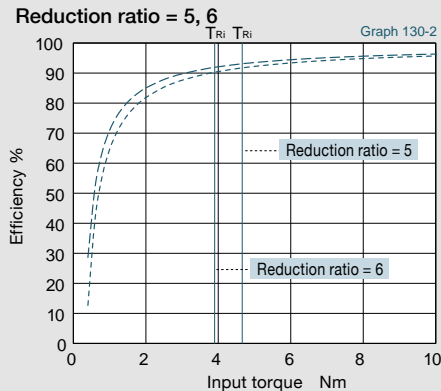
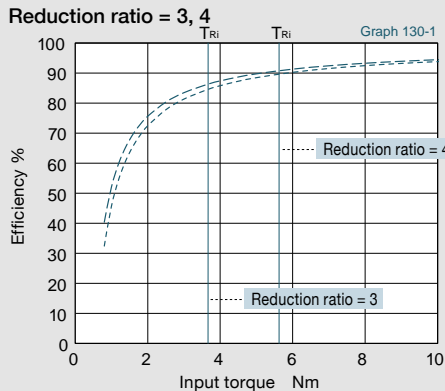

--- Gearhead with Z bearing (Double shielded) - - - - - Gearhead with D bearing (double sealed) T_{Ri} Input torque corresponding to output torque

Size 32 : Gearhead

HPG-Helical

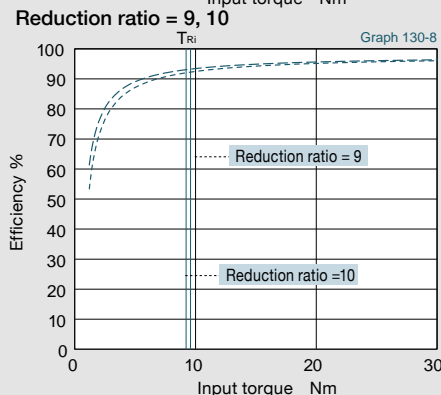
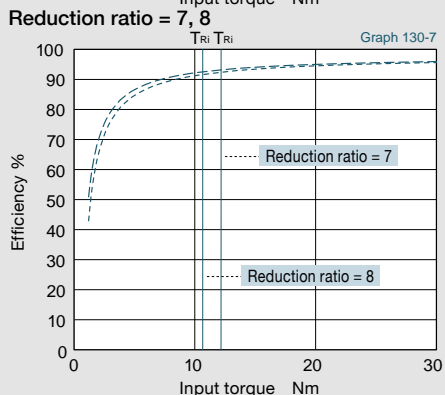
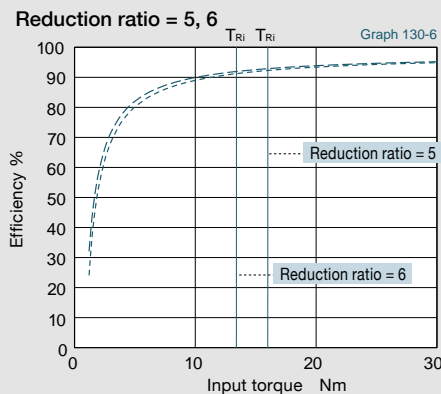
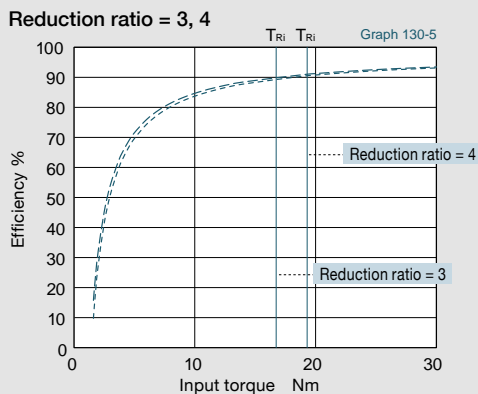

--- Gearhead with Z bearing (Double shielded) - - - - - Gearhead with D bearing (double sealed) T_{Ri} Input torque corresponding to output torque

Size 32 RA3 : Right Angle Gearhead

HPG

Reduction ratio = 5

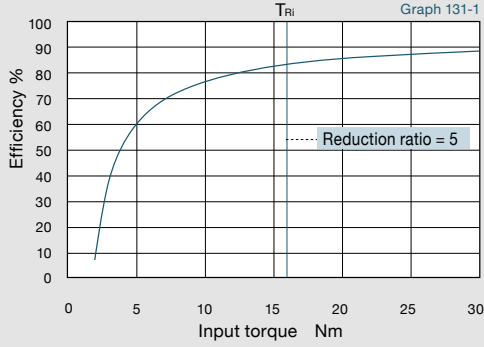

Reduction ratio = 11

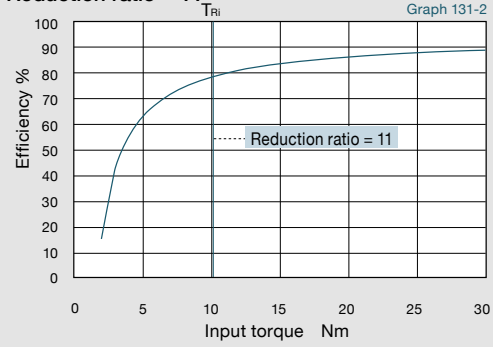

Reduction ratio = 15, 21

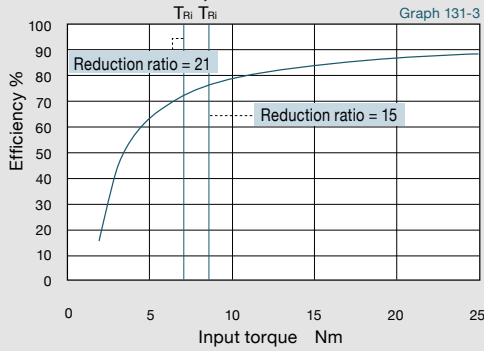

Reduction ratio = 33, 45

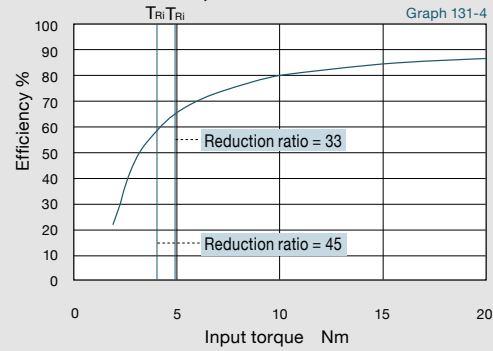

T_{Ri} Input torque corresponding to output torque

Size 50 RA3 : Right Angle Gearhead

HPG

Reduction ratio = 5

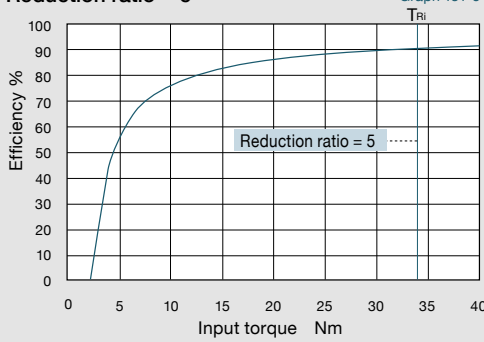

Reduction ratio = 11

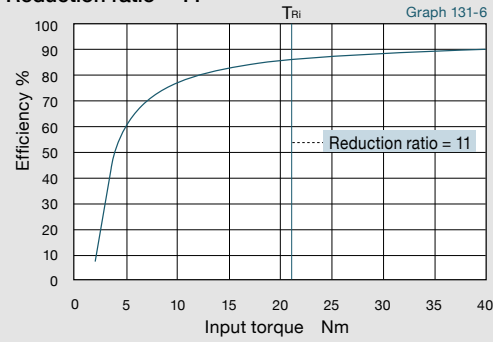

Reduction ratio = 15, 21

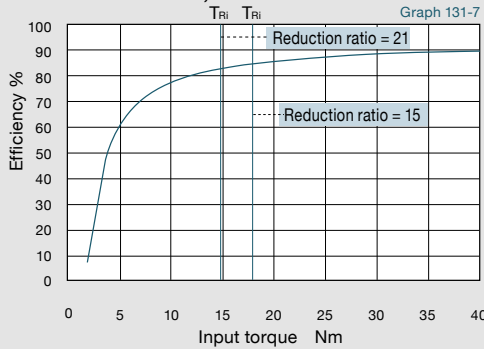

Reduction ratio = 33, 45

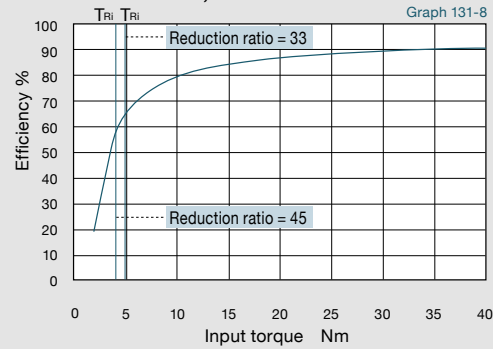

T_{Ri} Input torque corresponding to output torque

Size 50 RA5 : Right Angle Gearhead

HPG

Reduction ratio = 5

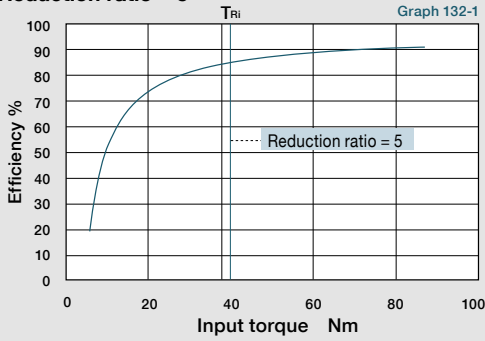

Reduction ratio = 11

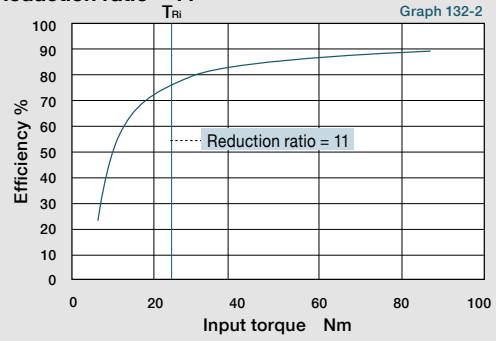

Reduction ratio = 15, 21

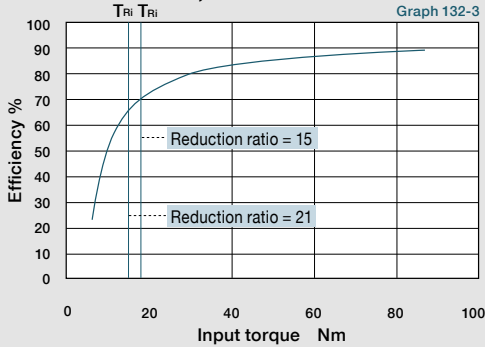

Reduction ratio = 33, 45

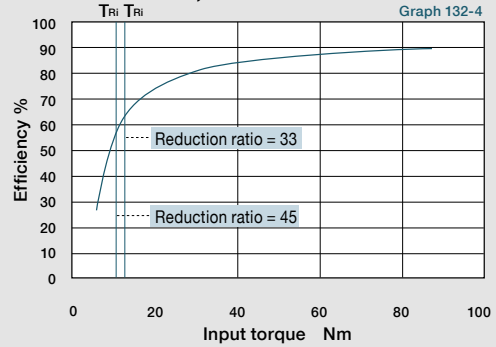

T_{Ri} Input torque corresponding to output torque

Size 65 RA5 : Right Angle Gearhead

HPG

Reduction ratio = 5

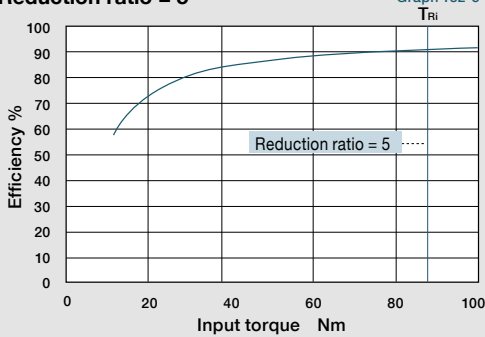

Reduction ratio = 12, 15

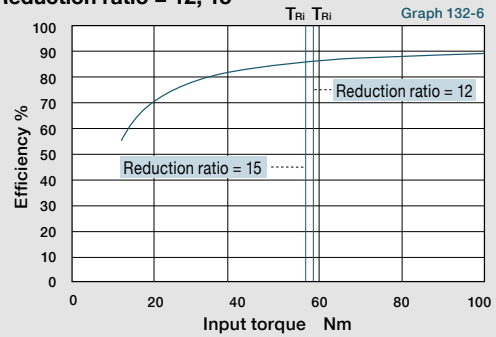

Reduction ratio = 20, 25

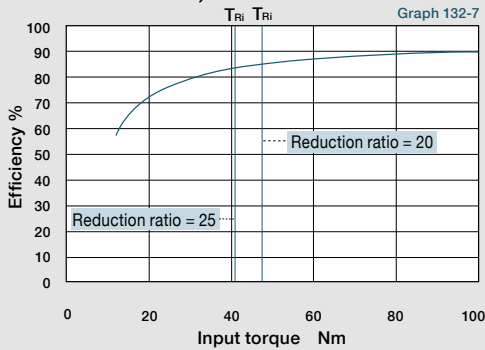

Reduction ratio = 40, 50

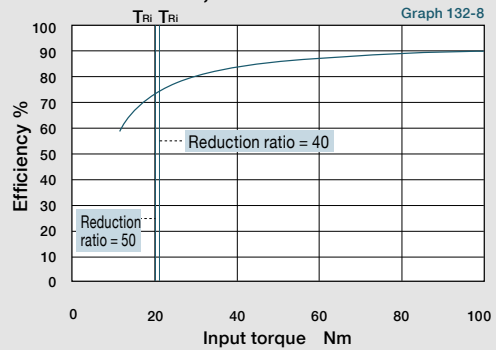

T_{Ri} Input torque corresponding to output torque

Size 11A : Gearhead

HPN

Reduction ratio = 4

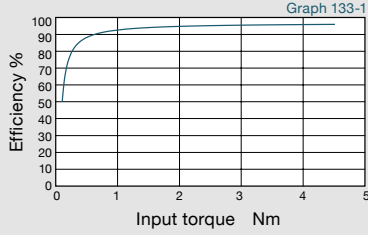

Reduction ratio = 5

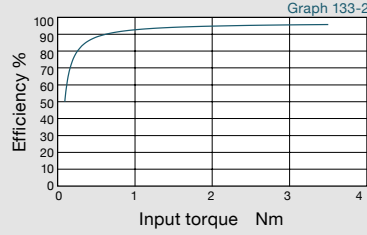

Reduction ratio = 7

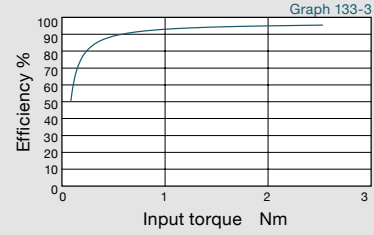

Reduction ratio = 10

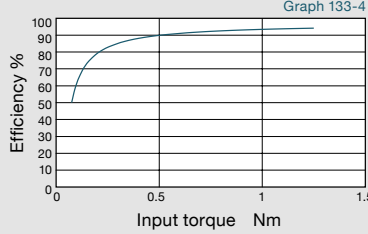

Reduction ratio = 16

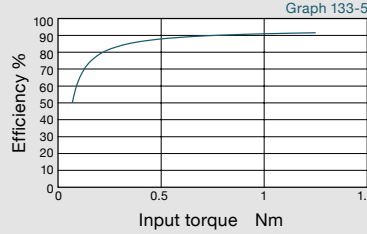

Reduction ratio = 20

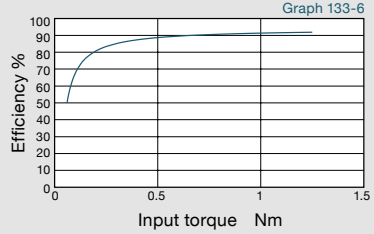

Reduction ratio = 30

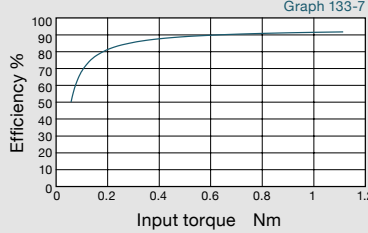

Size 14A : Gearhead

HPN

Reduction ratio = 3

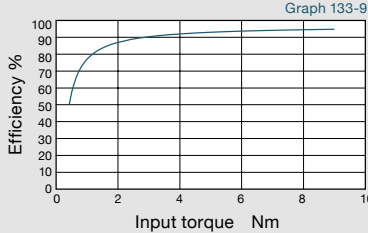

Reduction ratio = 4

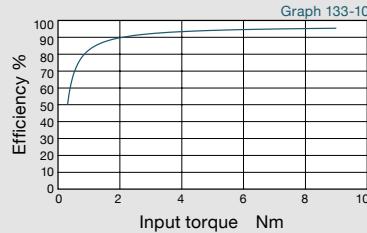

Reduction ratio = 5

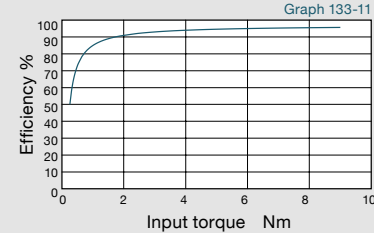

Reduction ratio = 7

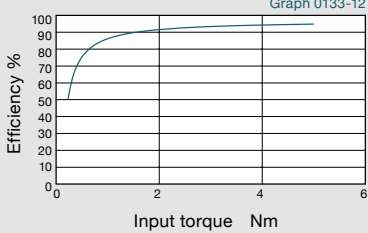

Reduction ratio = 10

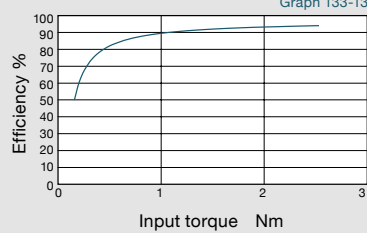

Reduction ratio = 13

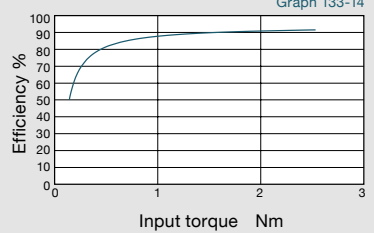

Reduction ratio = 21

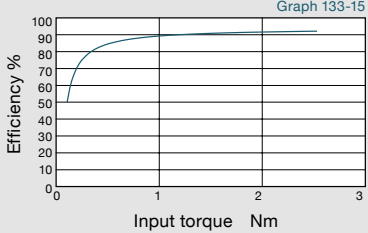

Reduction ratio = 31

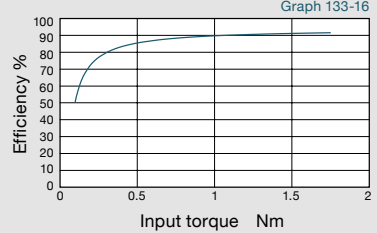

Size 20A : Gearhead

HPN

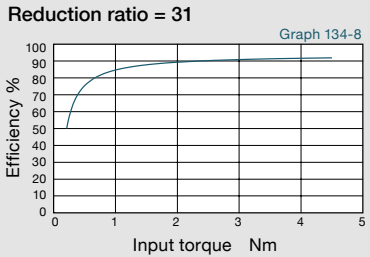
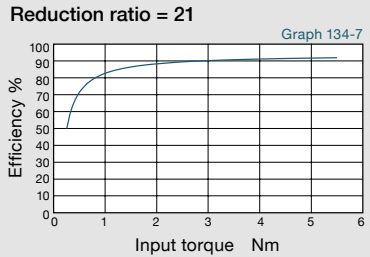
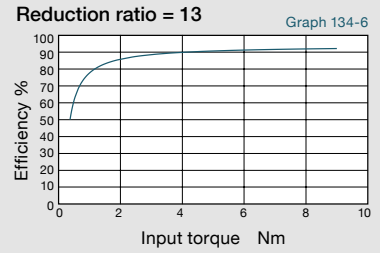
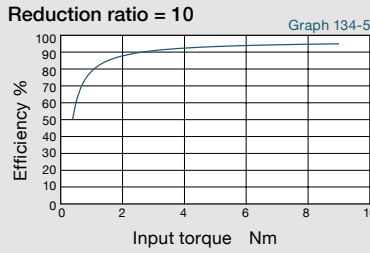
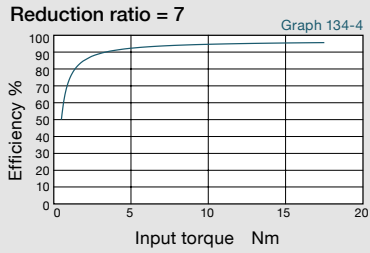
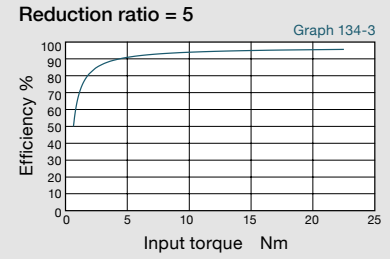
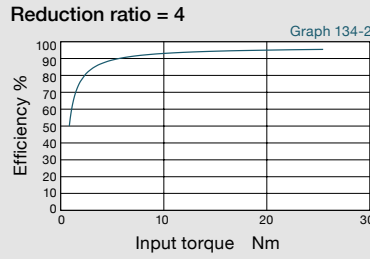
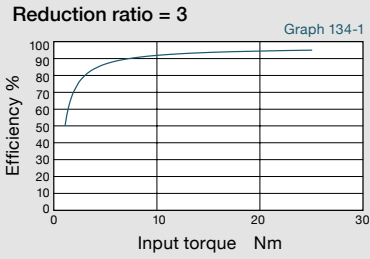

Size 32A : Gearhead

HPN

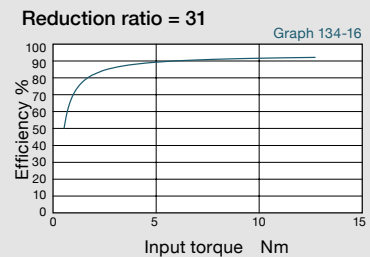
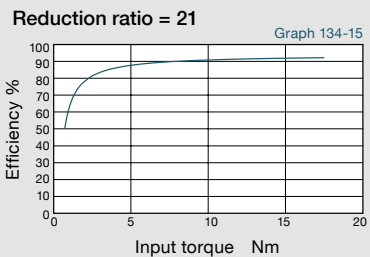
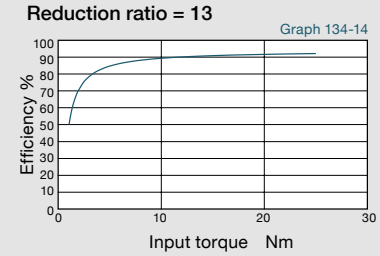
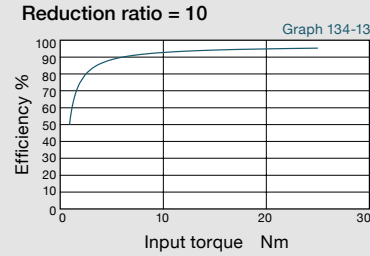
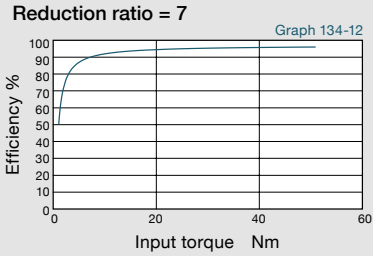
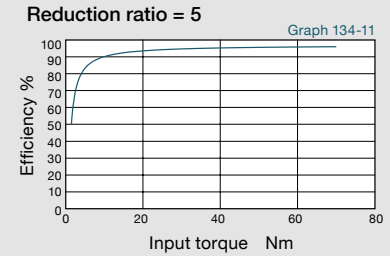
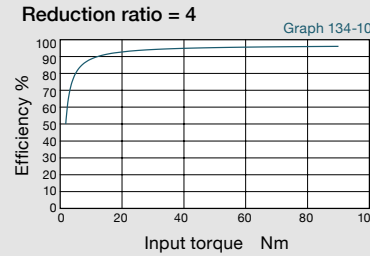
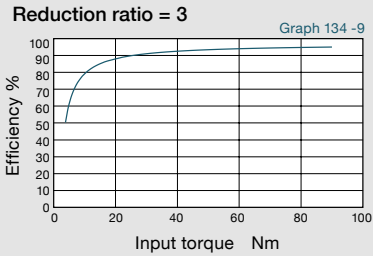

Size 40A

: Gearhead

HPN

Reduction ratio = 3

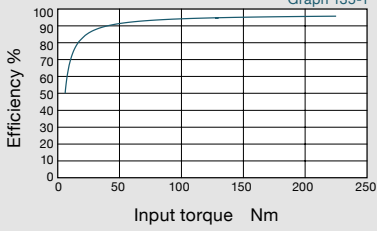

Reduction ratio = 4

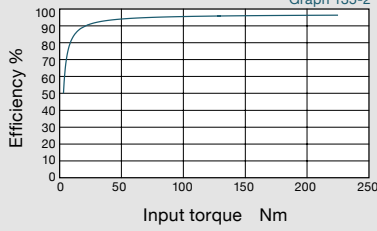

Reduction ratio = 5

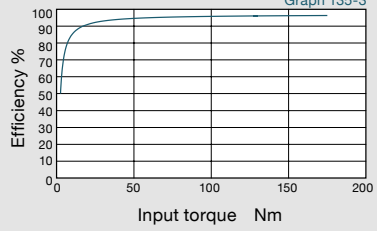

Reduction ratio = 7

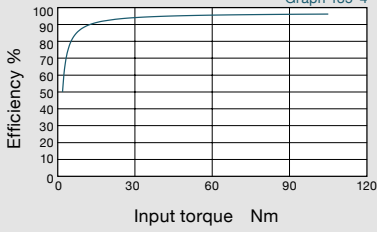

Reduction ratio = 10

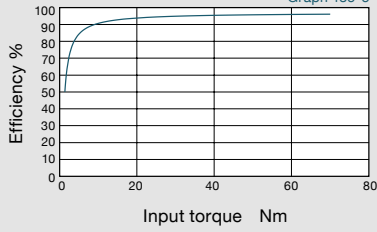

Reduction ratio = 13

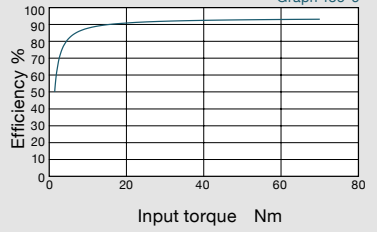

Reduction ratio = 21

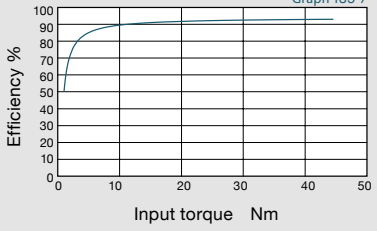

Reduction ratio = 31

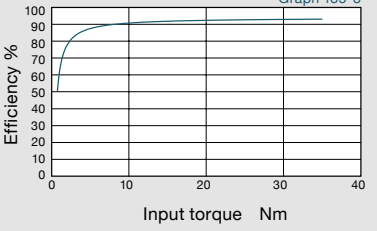

Size 25 : Hollow Shaft Unit

HPF

Reduction ratio = 11

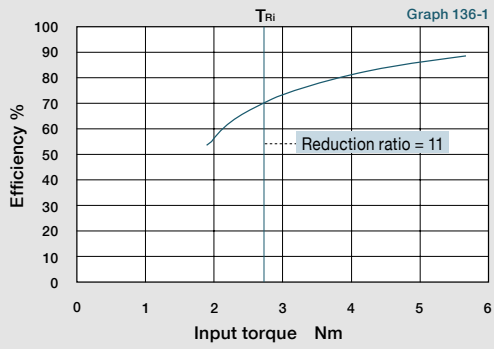

Size 32 : Hollow Shaft Unit

HPF

Reduction ratio = 11

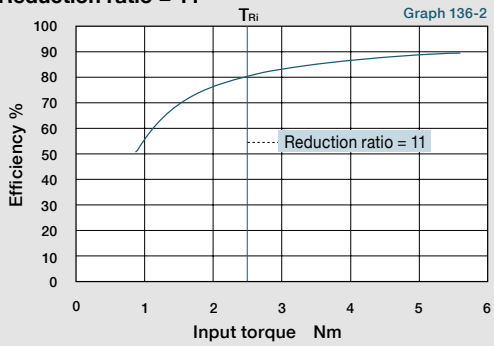

Size 14 : Gearhead

CSG-GH

CSF-GH

Reduction ratio = 50

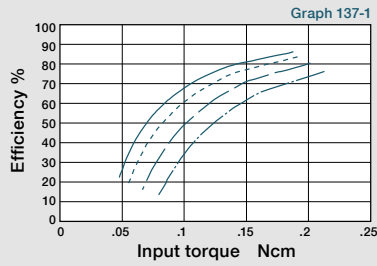

Reduction ratio = 80

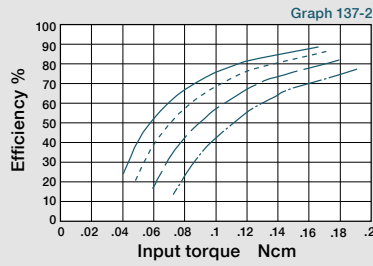

Reduction ratio = 100

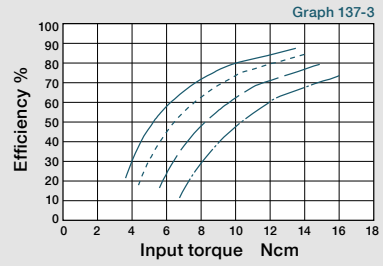

Input rotational speed — 500 rpm - - - - - 1000 rpm 2000 rpm - · - · - 3500 rpm

Size 20 : Gearhead

CSG-GH

CSF-GH

Reduction ratio = 50

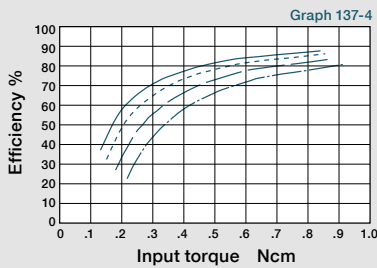

Reduction ratio = 80

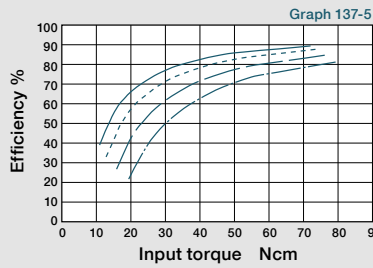

Reduction ratio = 100

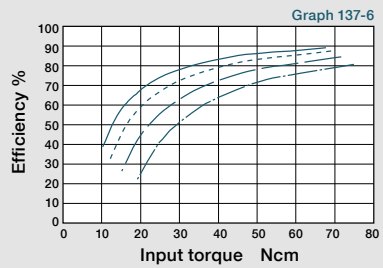

Reduction ratio = 120

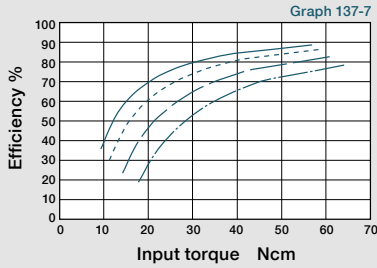

Reduction ratio = 160

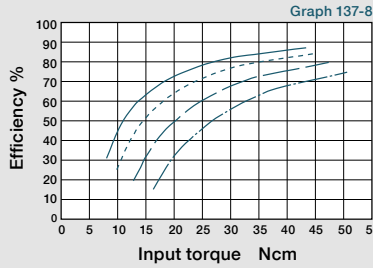

Input rotational speed — 500 rpm - - - - - 1000 rpm 2000 rpm - · - · - 3500 rpm

Size 32 : Gearhead

CSG-GH

CSF-GH

Reduction ratio = 50

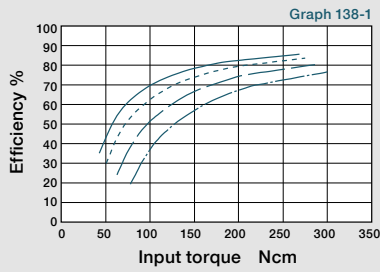

Reduction ratio = 80

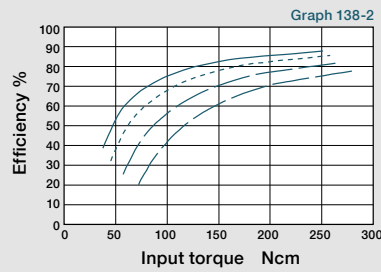

Reduction ratio = 100

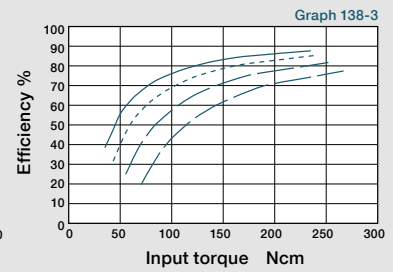

Reduction ratio = 120

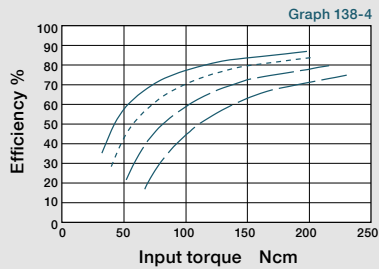

Reduction ratio = 160

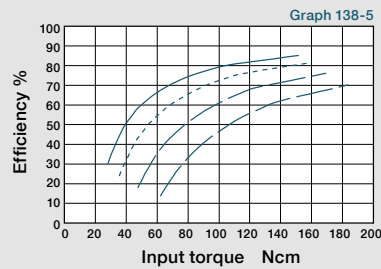

Input rotational speed — 500 rpm — 1000 rpm — 2000 rpm — 3500 rpm

Size 45 : Gearhead

CSG-GH

CSF-GH

Reduction ratio = 50

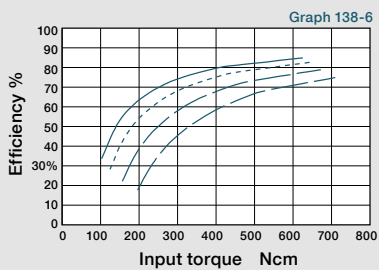

Reduction ratio = 80

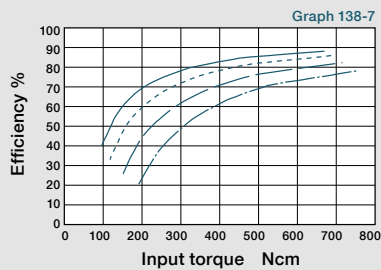

Reduction ratio = 100

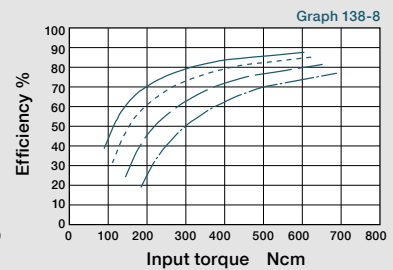

Reduction ratio = 120

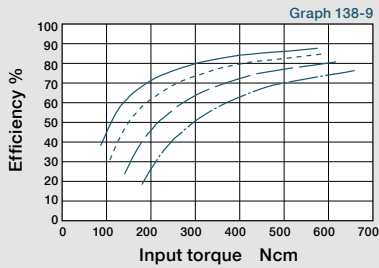

Reduction ratio = 160

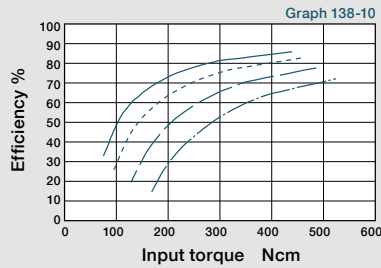

Input rotational speed — 500 rpm — 1000 rpm — 2000 rpm — 3500 rpm

Size 65

: Gearhead

CSG-GH

CSF-GH

Reduction ratio = 80

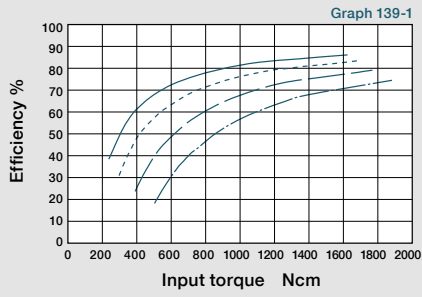

Reduction ratio = 100

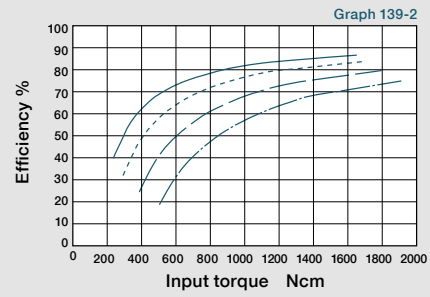

Reduction ratio = 120

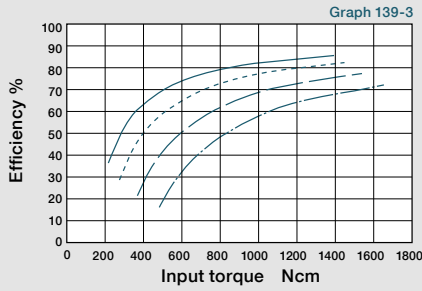

Reduction ratio = 160

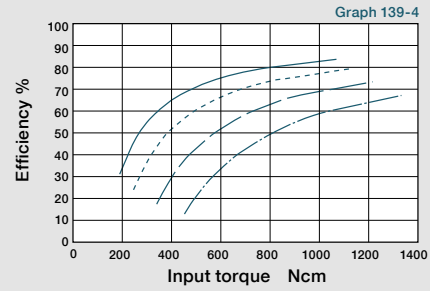

Input rotational speed — 500 rpm - - - 1000 rpm - · - 2000 rpm · · · 3500 rpm



Output Shaft Bearing Load Limits

HPN Series Output Shaft Load Limits are plotted below.

HPN uses radial ball bearings to support the output shaft. Please use the curve on the graph for the appropriate load coefficient (f_w) that represents the expected operating condition.

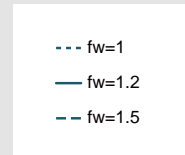
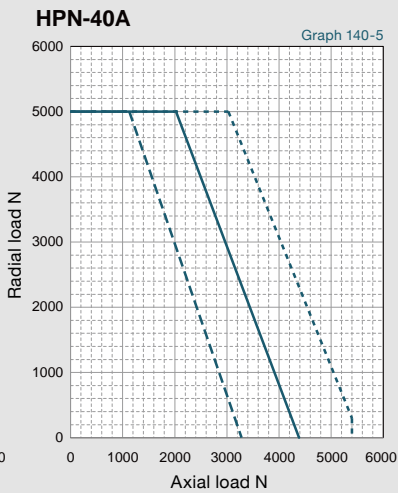
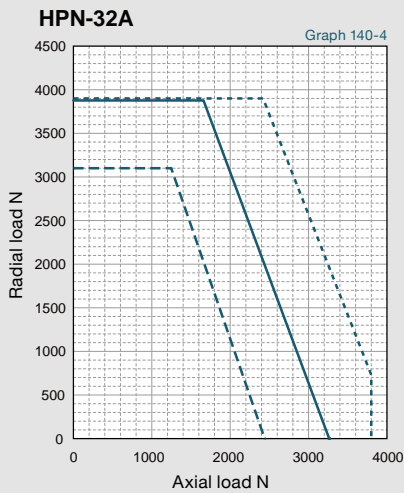
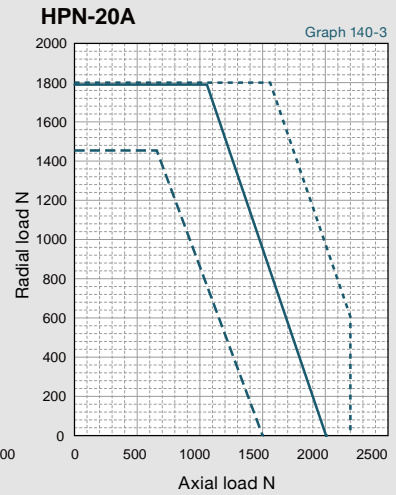
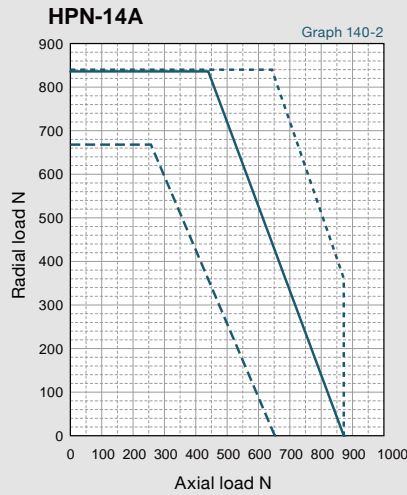
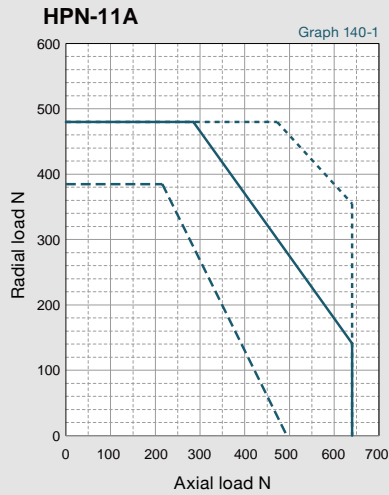

Load coefficient
 fw=1-1.2 Smooth operation
 without impact
 fw=1.2-1.5 Standard operation

Output shaft speed - 100 rpm, bearing life is based on 20,000 hours. The load-point is based on shaft center of radial load and axial load.

Output Bearing Specifications and Checking Procedure

HPGP, HPG, HPG Helical, CSF-GH, CSG-GH, HPF, and HPG-U1 are equipped with cross roller bearings. A precision cross roller bearing supports the external load (output flange). Check the maximum load, moment load, life of the bearing and static safety coefficient to maximize performance.

Checking procedure

(1) Checking the maximum moment load (M_{max})

Calculate the maximum moment load (M_{max}). $\bullet\bullet \rightarrow$ Maximum moment load (M_{max}) \leq Permissible moment (M_c)

(2) Checking the life

Calculate the average radial load (F_{rav}) and the average axial load (F_{aav}). $\bullet\bullet \rightarrow$ Calculate the radial load coefficient (X) and the axial load coefficient (Y). $\bullet\bullet \rightarrow$ Calculate the life and check it.

(3) Checking the static safety coefficient

Calculate the static equivalent radial load coefficient (P_o). $\bullet\bullet \rightarrow$ Check the static safety coefficient. (f_s)

Specification of output bearing

HPGP/HPG Series Tables 141-1, -2 and -3 indicate the cross roller bearing specifications for in-line, right angle and input shaft gears.

Table 141-1

Size	Pitch circle	Offset amount	Basic rated load				Allowable moment load M_c^{*3}		Moment stiffness K_m^{*4}	
	dp	R	Basic dynamic load rating C^{*1}		Basic static load rating C_o^{*2}		Nm	Kgf·m	$\times 10^4$ Nm/rad	Kgf·m/ arc min
	m	m	N	kgf	N	kgf				
11	0.0275	0.006	3116	318	4087	417	9.50	0.97	0.88	0.26
14	0.0405	0.011	5110	521	7060	720	32.3	3.30	3.0	0.90
20	0.064	0.0115	10600	1082	17300	1765	183	18.7	16.8	5.0
32	0.085	0.014	20500	2092	32800	3347	452	46.1	42.1	12.5
50	0.123	0.019	41600	4245	76000	7755	1076	110	100	29.7
65	0.170	0.023	90600	9245	148000	15102	3900	398	364	108

Table 141-2

Size	Reduction ratio	Allowable radial load ^{*5}	Allowable axial load ^{*5}
		N	N
11	5	280	430
	(9)	340	510
	21	440	660
	37	520	780
	45	550	830
14	(3)	400	600
	5	470	700
	11	600	890
	15	650	980
	21	720	1080
	33	830	1240
20	45	910	1360
	(3)	840	1250
	5	980	1460
	11	1240	1850
	15	1360	2030
	21	1510	2250
	33	1729	2580
45	1890	2830	

* The ratio specified in parentheses is for the HPG Series.

Table 141-3

Size	Reduction ratio	Allowable radial load ^{*5}	Allowable axial load ^{*5}
		N	N
32	(3)	1630	2430
	5	1900	2830
	11	2410	3590
	15	2640	3940
	21	2920	4360
	33	3340	4990
50	45	3670	5480
	(3)	3700	5570
	5	4350	6490
	11	5500	8220
	15	6050	9030
	21	6690	9980
	33	7660	11400
65	45	8400	12500
	4	8860	13200
	5	9470	14100
	12	12300	18300
	15	13100	19600
	20	14300	21400
	25	15300	22900
	(40)	17600	26300
	(50)	18900	28200

* The ratio specified in parentheses is for the HPG Series.

[Note: Table 141-1, -2 and -3 Table 142-1 and -2]

- *1 The basic dynamic load rating means a certain static radial load so that the basic dynamic rated life of the roller bearing is a million rotations.
- *2 The basic static load rating means a static load that gives a certain level of contact stress (4kN/mm²) in the center of the contact area between rolling element receiving the maximum load and orbit.
- *3 The allowable moment load is a maximum moment load applied to the bearing. Within the allowable range, basic performance is maintained and the bearing is operable. Check the bearing life based on the calculations shown on the next page.
- *4 The value of the moment stiffness is the average value.
- *5 The allowable radial load and allowable axial load are the values that satisfy the life of a speed reducer when a pure radial load or an axial load applies to the main bearing. ($L_r + R = 0$ mm for radial load and $L_a = 0$ mm for axial load) If a compound load applies, refer to the calculations shown on the next page.

CSG-GH/CSF-GH Series Table 142-1 indicates the specifications for cross roller bearing.

Table 142-1

Size	Pitch circle	Offset amount	Basic load rating				Allowable moment load Mc* ³		Moment stiffness Km* ⁴		Allowable radial load* ⁵	Allowable axial load* ⁵
	dp	R	Basic dynamic load rating C* ¹		Basic static load rating Co* ²		Nm	kgfm	×10 ⁴ Nm/rad	kgfm/ arc min		
	m	m	N	kgf	N	kgf					N	N
14	0.0405	0.011	5110	521	7060	720	27	2.76	3.0	0.89	732	1093
20	0.064	0.0115	10600	1082	17300	1765	145	14.8	17	5.0	1519	2267
32	0.085	0.014	20500	2092	32800	3347	258	26.3	42	12	2938	4385
45	0.123	0.019	41600	4245	76000	7755	797	81.3	100	30	5962	8899
65	0.170	0.0225	81600	8327	149000	15204	2156	220	323	96	11693	17454

HPF Series Table 142-2 indicates the specifications for cross roller bearing.

Table 142-2

Size	Pitch circle	Offset amount	Basic load rating				Allowable moment load Mc* ³		Moment stiffness Km* ⁴		Allowable radial load* ⁵	Allowable axial load* ⁵
	dp	R	Basic dynamic load rating C* ¹		Basic static load rating Co* ²		Nm	kgfm	×10 ⁴ Nm/rad	kgfm/ arc min		
	m	m	N	kgf	N	kgf					N	N
25	0.085	0.0153	11400	1163	20300	2071	410	41.8	37.9	11.3	1330	1990
32	0.1115	0.015	22500	2296	39900	4071	932	95	86.1	25.7	2640	3940

[Note: Table 141-1, -2 and -3 Table 142-1 and -2]

- *1 The basic dynamic load rating means a certain static radial load so that the basic dynamic rated life of the roller bearing is a million rotations.
- *2 The basic static load rating means a static load that gives a certain level of contact stress (4kN/mm²) in the center of the contact area between rolling element receiving the maximum load and orbit.
- *3 The allowable moment load is a maximum moment load applied to the bearing. Within the allowable range, basic performance is maintained and the bearing is operable. Check the bearing life based on the calculations shown on the next page.
- *4 The value of the moment stiffness is the average value.
- *5 The allowable radial load and allowable axial load are the values that satisfy the life of a speed reducer when a pure radial load or an axial load applies to the main bearing. (Lr + R = 0 mm for radial load and La = 0 mm for axial load) If a compound load applies, refer to the calculations shown on the next page.

How to calculate the maximum moment load

- HPGP
- HPG
- CSG-GH
- CSF-GH
- HPF

Maximum moment load (M_{max}) is obtained as follows. Make sure that $M_{max} \leq Mc$.

Formula 143-1

$$M_{max} = Fr_{max}(L_r + R) + Fa_{max}La$$

Fr_{max}	Max. radial load	N (kgf)	See Fig. 143-1.
Fa_{max}	Max. axial load	N (kgf)	See Fig. 143-1.
L_r, La	—	m	See Fig. 143-1.
R	Offset amount	m	See Fig. 143-1. See "Output Bearing Specifications" of each series, p.141 & 142

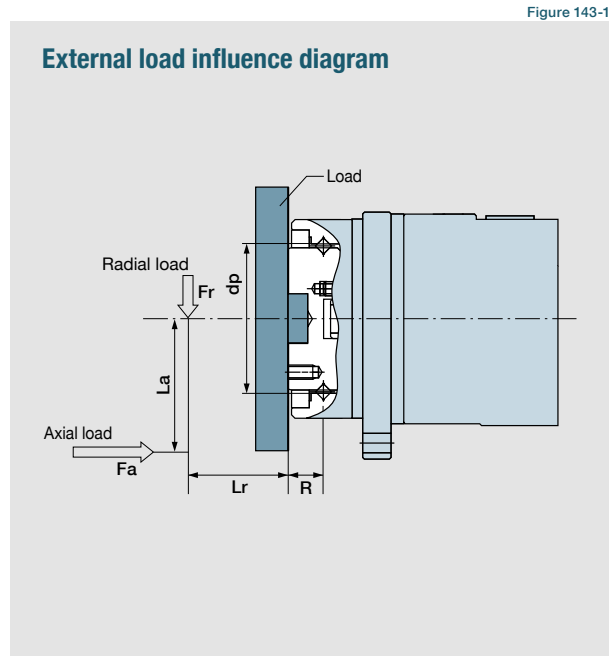

How to calculate the radial and the axial load coefficient

- HPGP
- HPG
- CSG-GH
- CSF-GH
- HPF

The radial load coefficient (X) and the axial load coefficient (Y)

Formula 143-2

Formula	X	Y
$\frac{Fa_{av}}{Fr_{av} + 2(Fr_{av}(L_r + R) + Fa_{av} \cdot La) / dp} \leq 1.5$	1	0.45
$\frac{Fa_{av}}{Fr_{av} + 2(Fr_{av}(L_r + R) + Fa_{av} \cdot La) / dp} > 1.5$	0.67	0.67

Fr_{av}	Average radial load	N (kgf)	See "How to calculate the average load below."
Fa_{av}	Average axial load	N (kgf)	See "How to calculate the average load below."
L_r, La	—	m	See Fig. 143-1.
R	Offset amount	m	See Fig. 143-1. See "Output Bearing Specifications" of each series, p. 141 & 142.
dp	Circular pitch of roller	m	See Fig. 143-1. See "Output Bearing Specifications" of each series, p. 141 & 142.

How to calculate the average load (Average radial load, average axial load, average output speed)

- HPGP
- HPG
- CSG-GH
- CSF-GH
- HPF

If the radial load and the axial load fluctuate, they should be converted into the average load to check the life of the cross roller bearing.

How to obtain the average radial load (Fr_{av}) Formula 143-3

$$Fr_{av} = \sqrt[10/3]{\frac{n_1 t_1 (|Fr_1|)^{10/3} + n_2 t_2 (|Fr_2|)^{10/3} + \dots + n_n t_n (|Fr_n|)^{10/3}}{n_1 t_1 + n_2 t_2 + \dots + n_n t_n}}$$

Note that the maximum radial load within the t_1 section is Fr_1 and the maximum radial load within the t_3 section is Fr_3 .

How to obtain the average axial load (Fa_{av}) Formula 143-4

$$Fa_{av} = \sqrt[10/3]{\frac{n_1 t_1 (|Fa_1|)^{10/3} + n_2 t_2 (|Fa_2|)^{10/3} + \dots + n_n t_n (|Fa_n|)^{10/3}}{n_1 t_1 + n_2 t_2 + \dots + n_n t_n}}$$

Note that the maximum axial load within the t_1 section is Fa_1 and the maximum axial load within the t_3 section is Fa_3 .

How to obtain the average output speed (N_{av}) Formula 143-5

$$N_{av} = \frac{n_1 t_1 + n_2 t_2 + \dots + n_n t_n}{t_1 + t_2 + \dots + t_n}$$

How to calculate the life HPGP HPG CSG-GH CSF-GH HPF

Calculate the life of the cross roller bearing using Formula 144-1. You can obtain the dynamic equivalent load (P_c) using Formula 144-2.

Formula 144-1

$$L_{10} = \frac{10^6}{60 \times N_{av}} \times \left(\frac{C}{f_w \cdot P_c} \right)^{10/3}$$

L₁₀	Life	hour	—
N_{av}	Ave. output speed	rpm	See "How to calculate the ave. load."
C	Basic dynamic load rating	N (kgf)	See "Output Bearing Specs."
P_c	Dynamic equivalent load	N (kgf)	See Formula 144-2.
f_w	Load coefficient	—	See Table 144-1.

Formula 144-2

$$P_c = X \cdot \left(Fr_{av} + \frac{2(Fr_{av}(L_r + R) + Fa_{av} \cdot La)}{dp} \right) + Y \cdot Fa_{av}$$

Fr_{av}	Average radial load	N (kgf)	See "How to calculate the ave. load."
Fa_{av}	Average axial load	N (kgf)	
dp	Pitch Circle of roller	m	See "Output Bearing Specs."
X	Radial load coefficient	—	See "How to calculate the radial load coefficient and the axial load coefficient."
Y	Axial load coefficient	—	
L_r, La	—	m	See Figure 143-1. See "External load influence diagram."
R	Offset amount	m	See Figure 143-1. See "External load influence diagram" and "Output Bearing Specs" of each series.

Load coefficient Table 144-1

Load status	f _w
During smooth operation without impact or vibration	1 to 1.2
During normal operation	1.2 to 1.5
During operation with impact or vibration	1.5 to 3

How to calculate the life during oscillating motion HPGP HPG CSG-GH CSF-GH HPF

Calculate the life of the cross roller bearing during oscillating motion by Formula 144-3.

Formula 144-3

$$L_{oc} = \frac{10^6}{60 \times n_1} \times \frac{90}{\theta} \times \left(\frac{C}{f_w \cdot P_c} \right)^{10/3}$$

L_{oc}	Rated life under oscillating motion	hour	—
n₁	No. of reciprocating oscillation per min.	cpm	—
C	Basic dynamic load rating	N (kgf)	See "Output Bearing Specs."
P_c	Dynamic equivalent load	N (kgf)	See Formula 144-2.
f_w	Load coefficient	—	See Table 144-1.
θ	Oscillating angle /2	Deg.	See Figure 144-1.

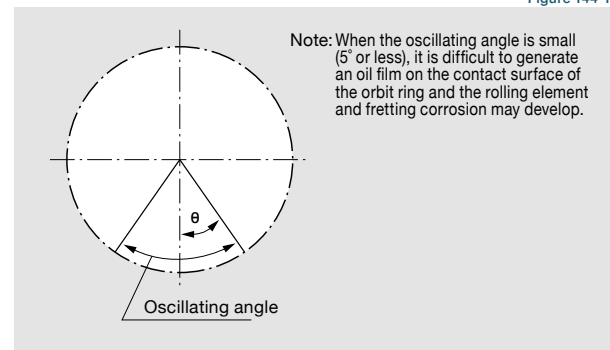

Note When it is used for a long time while the rotation speed of the output shaft is in the ultra-low operation range (0.02rpm or less), the lubrication of the bearing becomes insufficient, resulting in deterioration of the bearing or increased load in the output side. When using it in the ultra-low operation range, contact us.

How to calculate the static safety coefficient HPGP HPG CSG-GH CSF-GH HPF

In general, the basic static load rating (C_0) is considered to be the permissible limit of the static equivalent load. However, obtain the limit based on the operating and required conditions. Calculate the static safety coefficient (f_s) of the cross roller bearing using Formula 144-4.

General values under the operating condition are shown in Table 144-2. You can calculate the static equivalent load (P_0) using Formula 144-5.

Formula 144-4

$$f_s = \frac{C_0}{P_0}$$

C₀	Basic static load	N (kgf)	See "Output Bearing Specs."
P₀	Static equivalent load	N (kgf)	See Formula 144-5.

Formula 144-5

$$P_0 = Fr_{max} + \frac{2M_{max}}{dp} + 0.44Fa_{max}$$

Fr_{max}	Max. radial load	N (kgf)	
Fa_{max}	Max. axial load	N (kgf)	See "How to calculate the max. moment load."
M_{max}	Max. moment load	Nm (kgfm)	
dp	Pitch Circle	m	See "Output Bearing Specs" of each series.

Static safety coefficient Table 144-2

Load status	f _s
When high precision is required	≥ 3
When impact or vibration is expected	≥ 2
Under normal operating condition	≥ 1.5

Input Bearing Specifications and Checking Procedure

Check the maximum load and life of the bearing on the input side if the reducer is an HPG input shaft unit or an HPF hollow shaft unit.

Checking procedure

HPG

HPF

(1) Checking maximum load

Calculate:

Maximum moment load (Mi_{max})
Maximum axial load (Fai_{max})
Maximum radial load (Fri_{max})



Maximum moment load (Mi_{max}) \leq Allowable moment load (Mc)
Maximum axial load (Fai_{max}) \leq Allowable axial load (Fac)
Maximum radial load (Fri_{max}) \leq Allowable radial load (Frc)

(2) Checking the life

Calculate:

Average moment load (Mi_{av})
Average axial load (Fai_{av})
Average input speed (Ni_{av})



Calculate the life and check it.

Specification of input bearing

Specification of input bearing

HPG

Table 145-1

Size	Basic load rating			
	Basic dynamic load rating Cr		Basic static load rating Cor	
	N	kgf	N	kgf
11	2700	275	1270	129
14	5800	590	3150	320
20	9700	990	5600	570
32	22500	2300	14800	1510
50	35500	3600	25100	2560
65	51000	5200	39500	4050

Table 145-2

Size	Allowable moment load Mc		Allowable axial load Fac^{*1}		Allowable radial load Frc^{*2}	
	Nm	kgfm	N	kgf	N	kgf
11	0.16	0.016	245	25	20.6	2.1
14	6.3	0.64	657	67	500	51
20	13.5	1.38	1206	123	902	92
32	44.4	4.53	3285	335	1970	201
50	96.9	9.88	5540	565	3226	329
65	210	21.4	8600	878	5267	537

Specification of input shaft bearing

HPF

Table 145-3

Size	Basic load rating			
	Basic dynamic load rating Cr		Basic static load rating Cor	
	N	kgf	N	kgf
25	14500	1480	10100	1030
32	29700	3030	20100	2050

Table 145-4

Size	Allowable moment load Mc		Allowable axial load Fac^{*1}		Allowable radial load Frc^{*3}	
	Nm	kgfm	N	kgf	N	kgf
25	10	1.02	1538	157	522	53.2
32	19	1.93	3263	333	966	98.5

[Note: Table 145-2 and 145-4]

*1 The allowable axial load is the value of an axial load applied along the axis of rotation.

*2 The allowable radial load of HPG series is the value of a radial load applied at the mid-point of the input shaft.

*3 The allowable radial load of HPG series is the value of a radial load applied to the point of 20 mm from the shaft edge (input flange edge).

Calculating maximum moment load ON input shaft

The maximum moment load ($M_{i max}$) is calculated as follows.
Check that the following formulas are established in all circumstances:

Formula 146-1

$$M_{i max} = F_{ri max} \cdot L_{ri} + F_{ai max} \cdot L_{ai}$$

$F_{ri max}$	Max. radial load	N (kgf)	See Fig. 146-1.
$F_{ai max}$	Max. axial load	N (kgf)	See Fig. 146-1.
L_{ri}, L_{ai}	-----	m	See Fig. 146-1.

$$M_{i max} \leq M_c \text{ (Allowable moment load)}$$

$$F_{ai max} \leq F_{ac} \text{ (Allowable axial load)}$$

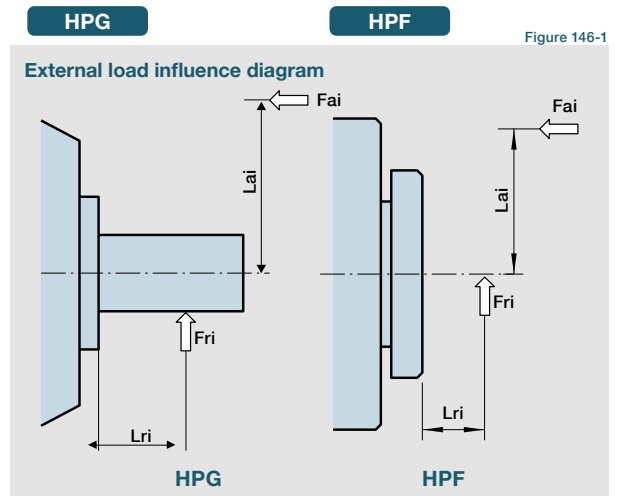

How to calculate average load (Average moment load, average axial load, average input speed)

If moment load and axial load fluctuate, they should be converted into the average load to check the life of the bearing.

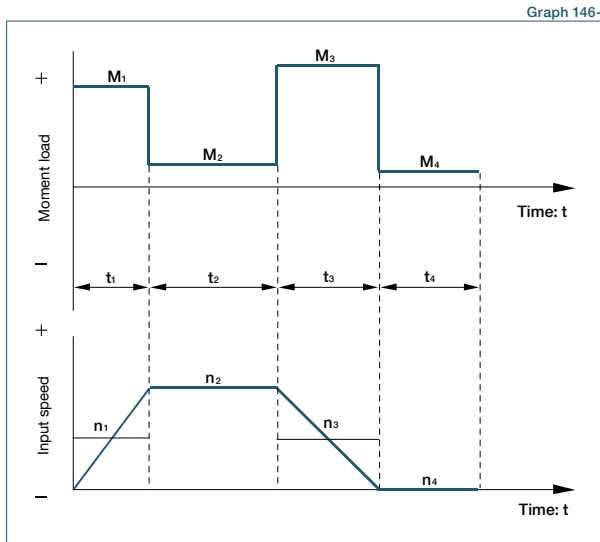

Formula 146-2

How to calculate the average moment load ($M_{i av}$)

$$M_{i av} = \sqrt[3]{\frac{n_1 t_1 (|M_{i1}|)^3 + n_2 t_2 (|M_{i2}|)^3 + \dots + n_n t_n (|M_{in}|)^3}{n_1 t_1 + n_2 t_2 + \dots + n_n t_n}}$$

Formula 146-3

How to calculate the average axial load ($F_{ai av}$)

$$F_{ai av} = \sqrt[3]{\frac{n_1 t_1 (|F_{ai1}|)^3 + n_2 t_2 (|F_{ai2}|)^3 + \dots + n_n t_n (|F_{ain}|)^3}{n_1 t_1 + n_2 t_2 + \dots + n_n t_n}}$$

Formula 146-4

How to calculate the average input speed ($N_{i av}$)

$$N_{i av} = \frac{n_1 t_1 + n_2 t_2 + \dots + n_n t_n}{t_1 + t_2 + \dots + t_n}$$

Calculating life of input bearing

Calculate the bearing life according to Calculation Formula 132-5 and check the life.

Formula 146-5

$$L_{10} = \frac{10^6}{60 \times N_{i av}} \times \left(\frac{C_r}{P_{ci}} \right)^3$$

L_{10}	Life	Hour	—
$N_{i av}$	Average input speed	rpm	See Formula 146-4
C_r	Basic dynamic load rating	N (kgf)	See Table 145-1 and -3
P_{ci}	Dynamic equivalent load	N	See Table 146-1 and -2

Table 146-1

Size	HPG	
	P_{ci}	
11	$0.444 \times M_{i av} + 1.426 \times F_{ai av}$	
14	$0.137 \times M_{i av} + 1.232 \times F_{ai av}$	
20	$0.109 \times M_{i av} + 1.232 \times F_{ai av}$	
32	$0.071 \times M_{i av} + 1.232 \times F_{ai av}$	
50	$0.053 \times M_{i av} + 1.232 \times F_{ai av}$	
65	$0.041 \times M_{i av} + 1.232 \times F_{ai av}$	

Table 146-2

Size	HPF	
	P_{ci}	
25	$121 \times M_{i av} + 2.7 \times F_{ai av}$	
32	$106 \times M_{i av} + 2.7 \times F_{ai av}$	

$M_{i av}$ Average moment load Nm (kgfm) See Formula 146-2
 $F_{ai av}$ Average axial load N (kgf) See Formula 146-3

Assembly

Assemble and mount your gearhead in accordance with these instructions to achieve the best performance. Be sure to use the recommended bolts and use a torque wrench to achieve the proper tightening torques as recommended in tables below.

Motor assembly procedure HPGP HPG CSG-GH CSF-GH HPN

To properly mount the motor to the gearhead, follow the procedure outlined below, refer to figure 147-1

- (1) Turn the input shaft coupling and align the bolt head with the rubber cap hole.

- (2) With the speed reducer in an upright position as illustrated in the figure below, slowly insert the motor shaft into the coupling of speed reducer. Slide the motor shaft without letting it drop down. If the speed reducer cannot be positioned upright, slowly insert the motor shaft into the coupling of speed reducer, then tighten the motor bolts evenly until the motor flange and gearhead flange are in full contact. Exercise care to avoid tilting the motor when inserting it into the gear head.

Bolt tightening torque

Table 147-1

Bolt size	M3	M4	M5	M6	M8	M10	M12
Tightening torque	Nm	2.0	4.5	9.0	15.3	37.2	73.5
	kgfm	0.20	0.46	0.92	1.56	3.8	7.5

Caution: Always tighten the bolts to the tightening torque specified in the table above. If the bolt is not tightened to the torque value recommended slippage of the motor shaft in the shaft coupling may occur. The bolt size will vary depending on the size of the gear and the shaft diameter of the mounted motor. Check the bolt size on the confirmation drawing provided.

Two setscrews need to be tightened on size 11. See the outline dimensions on page 22 (HPGP) and page 34 (HPG standard) and page 46 (HPG helical). Tighten the screws to the tightening torque specified below.

Table 147-2

Bolt size	M3	
Tightening torque	Nm	0.69
	kgfm	0.07

- (4) Fasten the motor to the gearhead flange with bolts.

Bolt* tightening torque

Table 147-3

Bolt size	M2.5	M3	M4	M5	M6	M8	M10	M12
Tightening torque	Nm	0.59	1.4	3.2	6.3	10.7	26.1	51.5
	kgfm	0.06	0.14	0.32	0.64	1.09	2.66	5.25

* Recommended bolt: JIS B 1176 Hexagon socket head bolt, Strength: JIS B 1051 12.9 or higher

Caution: Be sure to tighten the bolts to the tightening torques specified in the table.

- (5) Insert the rubber cap provided. This completes the assembly. (Size 11: Fasten screws with a gasket in two places)

Figure 147-1

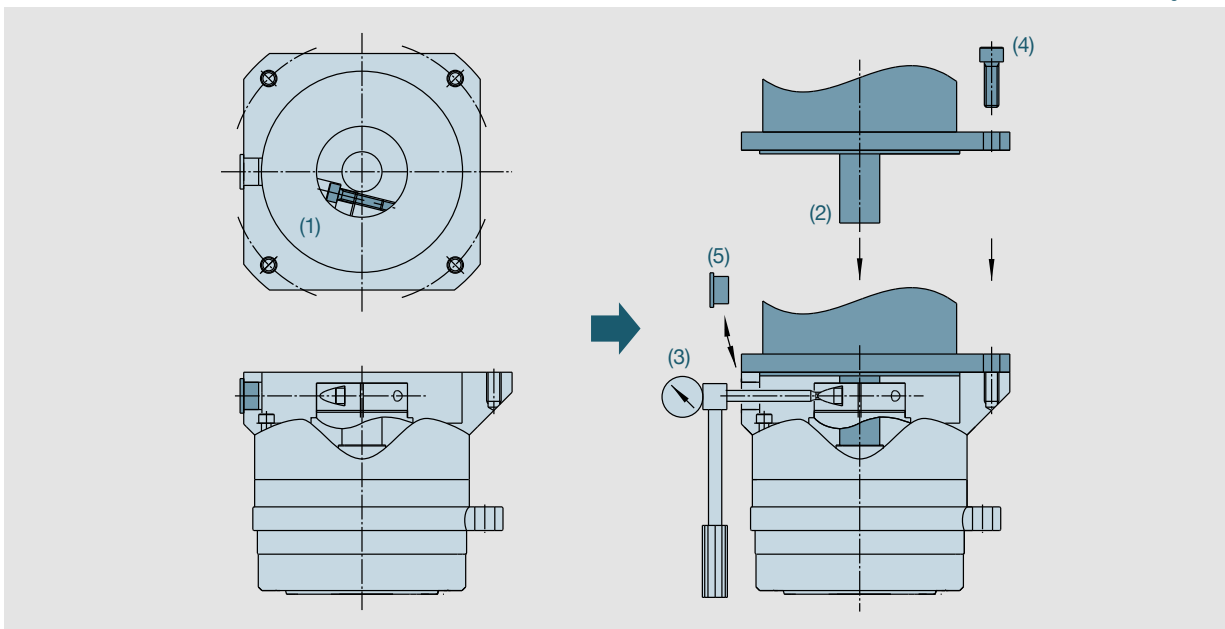

Speed reducer assembly

HPGP
HPG
CSG-GH
CSF-GH
HPF
HPN

Some right angle gearhead models weigh as much as 60 kg. No thread for an eyebolt is provided because the mounting orientation varies depending on the customer's needs. When mounting the reducer, hoist it using a sling paying extreme attention to safety.

When assembling gearheads into your equipment, check the flatness of your mounting surface and look for any burrs on tapped holes. Then fasten the flange (Part A in the diagram below) using appropriate bolts.

Bolt* tightening torque for flange (Part A in the diagram below)

Table 148-1

Size	HPN					HPGP / HPG / CSG-GH / CSF-GH						HPF		
	11	14	20	32	40	11	14	20	32	45/50	65	25	32	
Number of bolts	4	4	4	4	4	4	4	4	4	4	4	12	12	
Bolt size	M3	M5	M6	M8	M10	M3	M5	M8	M10	M12	M16	M4	M5	
Mounting PCD	mm	50	70	100	130	165	46	70	105	135	190	260	127	157
Tightening torque	Nm	1.4	6.3	10.7	26.1	51.5	1.4	6.3	26.1	51.5	103	255	4.5	9.0
	kgfm	0.14	0.64	1.09	2.66	5.26	0.14	0.64	2.66	5.25	10.5	26.0	0.46	0.92
Transmission torque	Nm	27.9	110	223	528	1063	26.3	110	428	868	2030	5180	531	1060
	kgfm	2.85	11.3	22.8	53.9	108.5	2.69	11.3	43.6	88.6	207	528	54.2	108

* Recommended bolts: JIS B 1176 "Hexagon socket head bolts." Strength classification 12.9 or higher in JIS B 1051.

Mounting the load to the output flange

Follow the specifications in the table below when mounting the load onto the output flange.

Figure 148-1

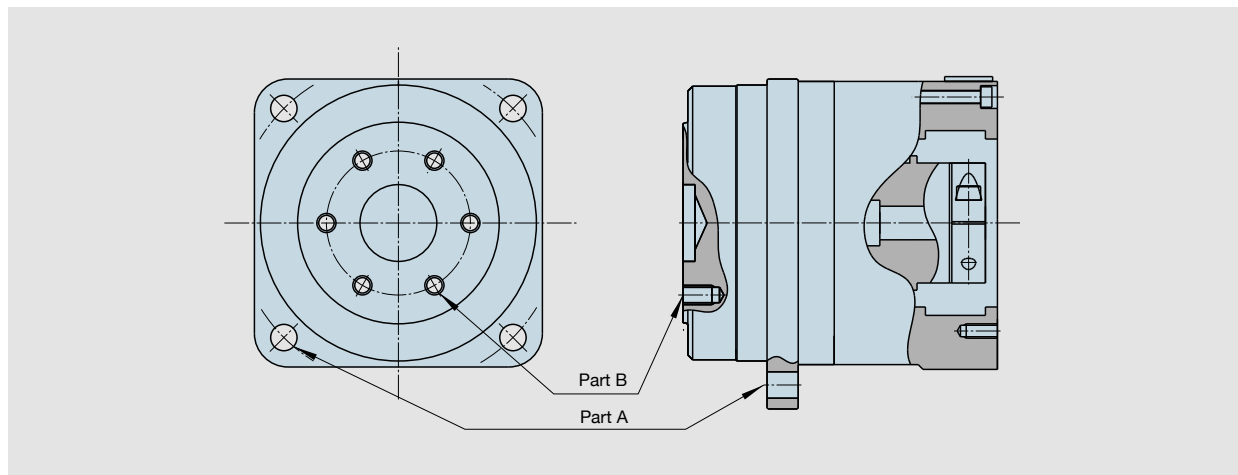

Output flange mounting specifications

Bolt* tightening torque for output flange (Part B in the Figure 148-1)

HPGP

Table 148-2

Size	11	14	20	32	50	65	
Number of bolts	4	8	8	8	8	8	
Bolt size	M4	M4	M6	M8	M12	M16	
Mounting PCD	mm	18	30	45	60	90	120
Tightening torque	Nm	4.5	4.5	15.3	37.2	128.4	319
	kgfm	0.46	0.46	1.56	3.8	13.1	32.5
Transmission torque	Nm	25.3	84	286	697	2407	5972
	kgfm	2.58	8.6	29.2	71.2	245	609

* Recommended bolts: JIS B 1176 "Hexagon socket head bolts." Strength classification 12.9 or higher in JIS B 1051.

Bolt* tightening torque for output flange (Part B in the Figure 148-1)

HPG

Table 148-3

Size	11	14	20	32	50	65	
Number of bolts	3	6	6	6	14	6	
Bolt size	M4	M4	M6	M8	M8	M16	
Mounting PCD	mm	18	30	45	60	100	120
Tightening torque	Nm	4.5	4.5	15.3	37.2	37.2	319
	kgfm	0.46	0.46	1.56	3.8	3.80	32.5
Transmission torque	Nm	19.0	63	215	524	2036	4480
	kgfm	1.9	6.5	21.9	53.4	207.8	457

* Recommended bolts: JIS B 1176 "Hexagon socket head bolts." Strength classification 12.9 or higher in JIS B 1051.

Mounting the load to the output flange

Bolt* tightening torque for output flange (Part B in Figure 148-1)

CSG-GH

Table 149-1

Size		14	20	32	45	65
Number of bolts		8	8	10	10	10
Bolt size		M4	M6	M8	M12	M16
Mounting PCD	mm	30	45	60	94	120
	Nm	4.5	15.3	37	128	319
Tightening torque	kgfm	0.46	1.56	3.8	3.1	32.5
	Nm	84	287	867	3067	7477
Transmission torque	kgfm	8.6	29.3	88.5	313	763

Bolt* tightening torque for output flange (Part B in Figure 148-1)

CSF-GH

Table 149-2

Size		14	20	32	45	65
Number of bolts		6	6	6	16	8
Bolt size		M4	M6	M8	M8	M16
Mounting PCD	mm	30	45	60	100	120
	Nm	4.5	15.3	37.2	37.2	319
Tightening torque	kgfm	0.46	1.56	3.80	3.80	32.5
	Nm	63	215	524	2326	5981
Transmission torque	kgfm	6.5	21.9	53.4	237	610

Bolt* tightening torque for output flange
(Part B in Figure 148-1)

HPF

Table 149-3

Size		25	32
Number of bolts		12	12
Bolt size		M4	M5
Mounting PCD	mm	77	100
	Nm	4.5	9.0
Tightening torque	kgfm	0.46	0.92
	Nm	322	675
Transmission torque	kgfm	32.9	68.9

* Recommended bolts: JIS B 1176 "Hexagon socket head bolts." Strength classification 12.9 or higher in JIS B 1051.

Gearheads with an output shaft

HPN

HPG

HPGP

CSG-GH

CSF-GH

HPF

Do not subject the output shaft to any impact when mounting a pulley, pinion or other parts.

An impact to the the output bearing may affect the speed reducer precision and may cause reduced life or failure.

Mechanical Tolerances

Superior mechanical precision is achieved by integrating the output flange with a high-precision cross roller bearing as a single component. The mechanical tolerances of the output shaft and mounting flange are specified below.

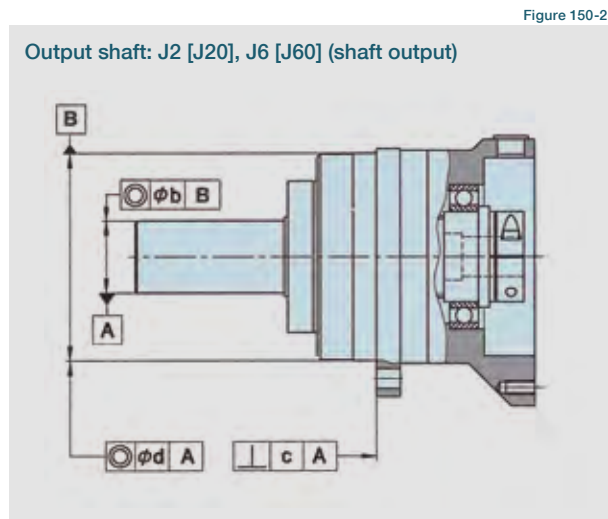
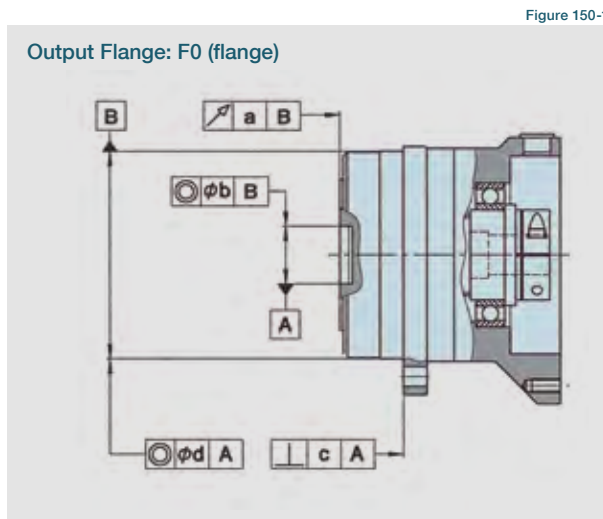

HPGP **HPG** **CSG-GH** **CSF-GH**

Table 150-1

Size	Axial runout of output flange a	Radial runout of output flange pilot or output shaft b	Perpendicularity of mounting flange c	Concentricity of mounting flange d
11	0.020	0.030	0.050	0.040
14	0.020	0.040	0.060	0.050
20	0.020	0.040	0.060	0.050
32	0.020	0.040	0.060	0.050

HPGP **HPG**

Table 150-2

50	0.020	0.040	0.060	0.050
65	0.040	0.060	0.090	0.080

CSG-GH **CSF-GH**

Table 150-3

45	0.020	0.040	0.060	0.050
65	0.020	0.040	0.060	0.050

HPF

Table 150-4

25	0.020	0.040	0.060	0.050
32	0.020	0.040	0.060	0.050

* T.I.R.: Total indicator reading

(T.I.R.* Unit: mm)

Lubrication

Prevention of grease and oil leakage

(Common to all models)

- Only use the recommended greases.
- Provisions for proper sealing to prevent grease leakage are incorporated into the gearheads. However, please note that some leakage may occur depending on the application or operating condition. Discuss other sealing options with our applications engineers.
- When mounting the gearhead horizontally, position the gearhead so that the rubber cap in the adapter flange is facing upwards.

(CSG/CSF-GH Series)

- Contact us when using HarmonicDrive® CSG/CSF-GH series with the output shaft facing downward (motor on top) at a constant load or rotating continuously in one direction.

Sealing

(Common to all models)

- Provisions for proper sealing to prevent grease leakage from the input shaft are incorporated into the gearhead.
- A double lip Teflon oil seal is used for the output shaft (HPGP/HPG uses a single lip seal), gaskets or o-rings are used on all mating surfaces, and non contact shielded bearings are used for the motor shaft coupling (Double sealed bearings (D type) are available as an option*). On the CSG/CSF-GH series, non contact shielded bearing and a Teflon oil seal with a spring is used.
- Material and surface: Gearbox: Aluminum, corrosion protected roller bearing steel, carbon steel (output shaft). Adapter flange: (if provided by Harmonic Drive) high-strength aluminum or carbon steel. Screws: black phosphate. The ambient environment should not subject any corrosive agents to the above mentioned material. The product provides protection class IP 65 under the provision that corrosion from the ambient atmosphere (condensation, liquids or gases) at the running surface of the output shaft seal is prevented. If necessary, the adapter flange can be sealed by means of a surface seal (e.g. Loctite 515).

* D type: Bearing with a rubber contact seal on both sides

(HPG/HPGP/HPF/HPN Series)

- Using the double sealed bearing (D type) for the HPGP/HPG series gearhead will result in a slightly lower efficiency compared to the standard product.
- An oil seal without a spring is used ON the input side of HPG series with an input shaft (HPG-1U) and HPF series hollow shaft reducer. An option for an oil seal with a spring is available for improved seal reliability, however, the efficiency will be slightly lower (available for HPF and HPG series for sizes 14 and larger).
- Do not remove the screw plug and seal cap of the HPG series right angle gearhead. Removing them may cause leakage of grease or affect the precision of the gear.

Standard Lubricants

HPG/HPGP/HPF/HPN Series

The standard lubrication for the HPG/HPGP/HPF/HPN series gearheads is grease.

All gearheads are lubricated at the factory prior to shipment and additional application of grease during assembly is not required.

The gearheads are lubricated for the life of the gear and do not require re-lubrication.

High efficiency is achieved through the unique planetary gear design and grease selection.

Lubricants

Harmonic Grease SK-2 (HPGP/HPG-14, 20, 32)
Manufacturer: Harmonic Drive Systems Inc.

Base oil: Refined mineral oil	Consistency: 265 to 295 at 25°C
Thickening agent: Lithium soap	Dropping point: 198°C
Additive: Extreme pressure agent and other	Color: Green
Standard: NLGI No. 2	

EPNOC Grease AP (N) 2 (HPGP/HPG-11, 50, 65/HPF-25, 32)
Manufacturer: Nippon Oil Co.

Base oil: Refined mineral oil	Consistency: 282 at 25°C
Thickening agent: Lithium soap	Dropping point: 200°C
Additive: Extreme pressure agent and other	Color: Light brown
Standard: NLGI No. 2	

PYRONOC UNIVERSAL 00 (HPG right angle gearhead/HPN)
Manufacturer: Nippon Oil Co.

Base oil: Refined mineral oil	Consistency: 420 at 25°C
Thickening agent: Urea	Dropping point: 250°C or higher
Standard: NLGI No. 00	Color: Light yellow

MULTEMP AC-P (HPG-X-R)
Manufacturer: KYODO YUSHI CO, LTD

Base oil: Composite hydrocarbon oil and diester	Standard: NLGI No. 2
Thickening agent: Lithium soap	Consistency: 280 at 25°C
Additive: Extreme pressure and others	Dropping point: 200°C
	Color: Black viscose

Ambient operating temperature range: -10°C to +40°C

The lubricant may deteriorate if the ambient operating temperature is outside of recommended operating range. Please contact our sales office or distributor for operation outside of the ambient operating temperature range.

The temperature rise of the gear depends upon the operating cycle, ambient temperature and heat conduction and radiation based on the customers installation of the gear. A housing surface temperature of 70°C is the maximum allowable limit.

CSG-GH/CSF-GH Series

The standard lubrication for the CGS-GH / CSF-GH series gearheads is grease. All gearheads are lubricated at the factory prior to shipment and additional application of grease during assembly is not necessary.

Lubricants

Harmonic Grease SK-1A (Size 20, 32, 45, 65)
Manufacturer: Harmonic Drive Systems Inc.

This grease has been developed exclusively for HarmonicDrive® gears and is excellent in durability and efficiency compared to commercial general-purpose grease.

Base oil: Refined mineral oil
Thickening Agent: Lithium soap
Additive: Extreme pressure agent and other
Standard: NLGI No. 2

Consistency: 265 to 295 at 25°C
Dropping point: 197°C
Color: Yellow

Harmonic Grease SK-2 (Size 14)
Manufacturer: Harmonic Drive Systems Inc.

This grease has been developed exclusively for smaller sized HarmonicDrive® gears and allows smooth wave generator rotation.

Base oil: Refined mineral oil
Thickening Agent: Lithium soap
Additive: Extreme pressure agent and other
Standard: NLGI No. 2

Consistency: 265 to 295 at 25°C
Dropping point: 198°C
Color: Green

Ambient operating temperature range: -10°C to +40°C

The lubricant may deteriorate if the ambient operating temperature is outside the recommended temperature range. Please contact our sales office or distributor for operation outside of the ambient operating temperature range.

The temperature rise of the gear depends upon the operating cycle, ambient temperature and heat conduction and radiation based on the customers installation of the gear. A housing surface temperature of 70°C is the maximum allowable limit.

When to change the grease

The life of the Harmonic Drive® gear is affected by the grease performance. The grease performance varies with temperature and deteriorates at elevated temperatures. Therefore, the grease will need to be changed sooner than usual when operating at higher temperatures. The graph on the right indicates when to change the grease based upon the temperature (when the average load torque is less than or equal to the rated output torque at 2000 rpm). Also, using the formula below, you can calculate when to change the grease when the average load torque exceeds the rated output torque (at 2000 rpm).

Formula to calculate the grease change interval when the average load torque exceeds the rated torque Formula 152-1

$$L_{GT} = L_{GTn} \times \left(\frac{T_r}{T_{av}} \right)^3$$

Formula symbols

Table 152-1

L_{GT}	Grease change interval when $T_{av} > T_r$	Input rotations	_____
L_{GTn}	Grease change interval when $T_{av} \leq T_r$	Input rotations	See Graph 152-1
T_r	Output torque at 2000 rpm	Nm, kgfm	See the "Rating table" on pages 77 & 87.
T_{av}	Average load torque	Nm, kgfm	Calculation formula: See page 100.

When to change the grease:
LGTn (when the average load torque is equal to or less than the rated output torque at 2000 rpm)

Figure 152-1

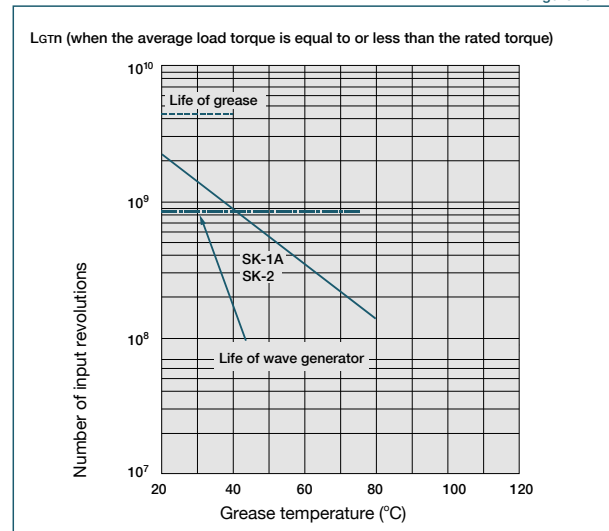

* L10 Life of wave generator bearing

Reference values for grease refill amount

Table 152-2

Size	14	20	32	45	65
Amount: g	0.8	3.2	6.6	11.6	78.6

Precautions when changing the grease

Strictly observe the following instructions when changing the grease to avoid problems such as grease leakage or increase in running torque.

- Note that the amount of grease listed in Table 152-2 is the amount used to lubricate the gear at assembly. This should be used as a reference. Do not exceed this amount when re-greasing the gearhead.
- Remove grease from the gearhead and refill it with the same quantity. The adverse effects listed above normally do not occur until the gear has been re-greased 2 times. When re-greasing 3 times or more, it is essential to remove grease (using air pressure or other means) before re-lubricating with the same amount of grease that was removed.

Warranty

Please contact us or visit our website at www.harmonicdrive.net for warranty details for your specific product.

All efforts have been made to ensure that the information in this catalog is complete and accurate. However, Harmonic Drive LLC is not liable for any errors, omissions or inaccuracies in the reported data. Harmonic Drive LLC reserves the right to change the product specifications, for any reason, without prior notice. For complete details please refer to our current Terms and Conditions posted on our website.

Disposal

When disposing of the product, disassemble it and sort the component parts by material type and dispose of the parts as industrial waste in accordance with the applicable laws and regulations. The component part materials can be classified into three categories.

- (1) Rubber parts: Oil seals, seal packings, rubber caps, seals of shielded bearings on input side (D type only)
- (2) Aluminum parts: Housings, motor flanges
- (3) Steel parts: Other parts

Trademark

HarmonicDrive® is a registered trademark of Harmonic Drive LLC.

HarmonicPlanetary® is a registered trademark of Harmonic Drive LLC.

Safety

 **Warning** : Means that improper use or handling could result in a risk of death or serious injury.

 **Caution** : Means that improper use or handling could result in personal injury or damage to property.





Application Restrictions









This product cannot be used for the following applications:





- * Space flight hardware
- * Aircraft equipment
- * Nuclear power equipment
- * Equipment and apparatus used in residential dwellings
- * Vacuum environments
- * Automotive equipment
- * Personal recreation equipment
- * Equipment that directly works on human bodies
- * Equipment for transport of humans
- * Equipment for use in a special environment
- * Medical equipment

Please consult Harmonic Drive LLC beforehand if intending to use one of our product for the aforementioned applications.

Fail-safe devices that prevent an accident must be designed into the equipment when the products are used in any equipment that could result in personal injury or damage to property in the event of product failure.

Design Precaution: Be certain to read the catalog when designing the equipment.	
 Caution	<p>Use only in the proper environment.</p> <ul style="list-style-type: none"> ● Please ensure to comply with the following environmental conditions: <ul style="list-style-type: none"> • Ambient temperature 0 to 40°C • No splashing of water or oil • Do not expose to corrosive or explosive gas • No dust such as metal powder
 Caution	<p>Install the equipment properly.</p> <ul style="list-style-type: none"> ● Carry out the assembly and installation precisely as specified in the catalog. ● Observe our recommended fastening methods (including bolts used and tightening torques). ● Operating the equipment without precise assembly can cause problems such as vibration, reduction in life, deterioration of precision and product failure.
 Caution	<p>Install the equipment with the required precision.</p> <ul style="list-style-type: none"> ● Design and assemble parts to keep all catalog recommended tolerances for installation. ● Failure to hold the recommended tolerances can cause problems such as vibration, reduction in life, deterioration of precision and product failure.
 Caution	<p>Use the specified lubricant.</p> <ul style="list-style-type: none"> ● Using other than our recommended lubricant can reduce the life of the product. Replace the lubricant as recommended. ● Gearheads are factory lubricated. Do not mix installed lubricant with other kinds of grease.

Operational Precaution: Be certain to read the catalog before operating the equipment.	
 Caution	<p>Use caution when handling the product and parts.</p> <ul style="list-style-type: none"> ● Do not hit the gear or any part with a hammer. ● If you use the equipment in a damaged condition, the gearhead may not perform to catalog specifications. It can also cause problems including product failure.
 Caution	<p>Operate within the allowable torque range.</p> <ul style="list-style-type: none"> ● Do not apply torque exceeding the momentary peak torque. Applying excess torque can cause problems such as loosened bolts, generation of backlash and product failure. ● An arm attached directly to the output shaft that strikes a solid object can damage the arm or cause the output of the gearhead to fail.
 Caution	<p>Do not alter or disassemble the product or parts.</p> <ul style="list-style-type: none"> ● Harmonic Planetary® and Harmonic Drive® products are manufactured as matched sets. Catalog ratings may not be achieved if the component parts are interchanged.
 Caution	<p>Do not disassemble the products.</p> <ul style="list-style-type: none"> ● Do not disassemble and reassemble the products. Original performance may not be achieved.
 Warning	<p>Do not use your finger to turn the gear.</p> <ul style="list-style-type: none"> ● Do not insert your finger into the gear under any circumstances. The finger may get caught in the gear causing an injury.
 Caution	<p>Stop operating the system if any abnormality occurs.</p> <ul style="list-style-type: none"> ● Shut down the system promptly if any abnormal sound or vibration is detected, the rotation has stopped, an abnormally high temperature is generated, an abnormal motor current value is observed or any other anomalies are detected. Continuing to operate the system may adversely affect the product or equipment. ● Please contact our sales office or distributor if any anomaly is detected.
 Warning	<p>Large sizes (45, 50 and 65) are heavy. Use caution when handling.</p> <ul style="list-style-type: none"> ● They are heavy and may cause a lower-back injury or an injury if dropped on a hand or foot. Wear protective shoes and back support when handling the product.
 Caution	<ul style="list-style-type: none"> ● Rust-proofing was applied before shipping. However, please note that rusting may occur depending on the customers' storage environment. ● Although black oxide finish is applied to some of our products, it does not guarantee that rust will not form.

Handling Lubricant	
 Warning	<p>Precautions on handling lubricants</p> <ul style="list-style-type: none"> ● Lubricant in the eye can cause inflammation. Wear protective glasses to prevent it from getting in your eye. ● Lubricant coming in contact with the skin can cause inflammation. Wear protective gloves when you handle the lubricant to prevent it from contacting your skin. ● Do not ingest (to avoid diarrhea and vomiting). ● Use caution when opening the container. There may be sharp edges that can cut your hand. Wear protective gloves. ● Keep lubricant out of reach of children.
 Caution	<p>Disposal of waste oil and containers</p> <ul style="list-style-type: none"> ● Follow all applicable laws regarding waste disposal. Contact your distributor if you are unsure how to properly dispose of the material. ● Do not apply pressure to an empty container. The container may explode. ● Do not weld, heat, drill or cut the container. This may cause residual oil to ignite or cause an explosion.
 Warning	<p>First-aid</p> <ul style="list-style-type: none"> ● Inhalation: Remove exposed person to fresh air if adverse effects are observed. ● Ingestion: Seek immediate medical attention and do not induce vomiting unless directed by medical personnel. ● Eyes: Flush immediately with water for at least 15 minutes. Get immediate medical attention. ● Skin: Wash with soap and water. Get medical attention if irritation develops.
 Caution	<p>Storage</p> <ul style="list-style-type: none"> ● Tightly seal the container after use. Store in a cool, dry, dark place. Keep away from open flames and high temperatures.
 Caution	<p>Disposal</p> <p>Please dispose of as industrial waste.</p> <ul style="list-style-type: none"> ● Please dispose of the products as industrial waste when their useful life is over.

Major Applications of Our Products



Metal Working Machines



Processing Machine Tools

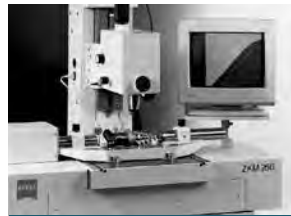

Measurement, Analytical and Test Systems



Medical Equipment



Telescopes

Source: National observatory of Inter-University Research Institute Corporation



Energy

Courtesy of Halliburton/Sperry Drilling Services

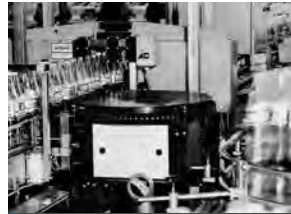

Crating and Packaging Machines



Communication Equipment



Space Flight Hardware

Rover image created by Dan Maas, copyrighted to Cornell and provided courtesy NASA/JPL-Caltech.

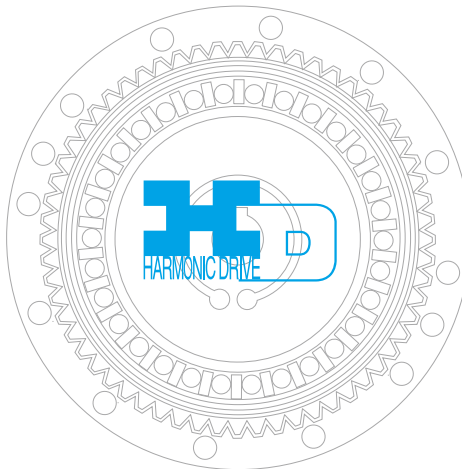

Glass and Ceramic Manufacturing Systems



Robots



Humanoid Robots

Source: Honda Motor Co., Ltd.



Printing, Bookbinding and Paper Machines

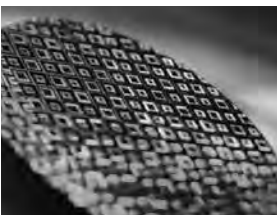

Semiconductor Manufacturing Equip.



Optical Equipment



Machine Tools



Paper-making Machines



Flat Panel Display Manufacturing Equip.

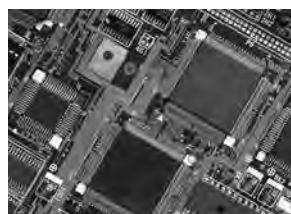

Printed Circuit Board Manufacturing Machines



Aerospace

Experts in Precision Motion Control

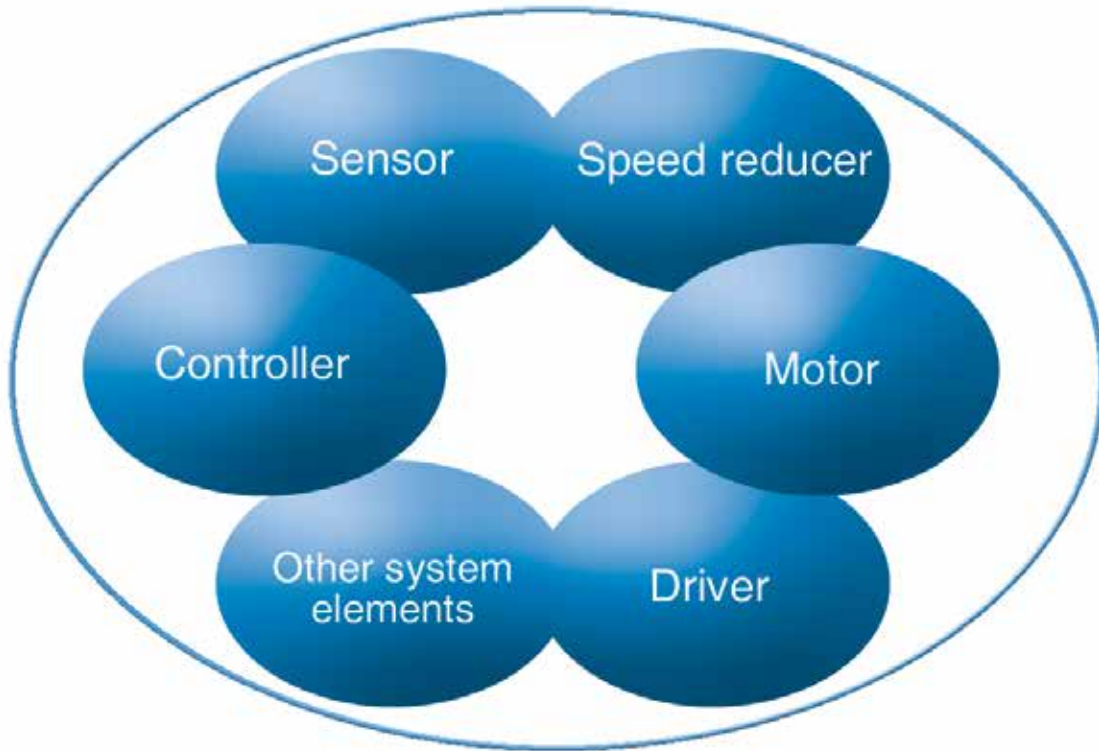

Other Products

HarmonicDrive® Gearing

HarmonicDrive® speed reducer delivers precise motion control by utilizing the strain wave gearing principle.

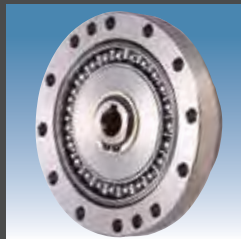

Rotary Actuators

High-torque actuators combine performance matched servomotors with HarmonicDrive® gears to deliver excellent dynamic control characteristics.

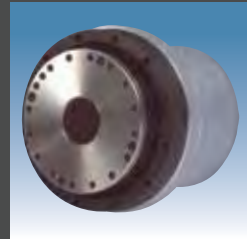

Linear Actuators

Compact linear actuators combine a precision lead screw and HarmonicDrive® gear. Our versatile actuators deliver both ultra precise positioning and high torque.



CSF Mini Gearheads

CSF mini gearheads provide high positioning accuracy in a super-compact package.



Harmonic Drive LLC

Boston US Headquarters

247 Lynnfield Street
Peabody, MA 01960

New York Sales Office

100 Motor Parkway
Suite 116
Hauppauge, NY 11788

California Sales Office

333 W. San Carlos Street
Suite 1070
San Jose, CA 95110

Chicago Sales Office

137 N. Oak Park Ave., Suite 410
Oak Park, IL 60301

T: 800.921.3332

T: 978.532.1800

F: 978.532.9406

www.HarmonicDrive.net

Group Companies

Harmonic Drive Systems, Inc.
6-25-3 Minami-Ohi, Shinagawa-ku
Tokyo 141-0013, Japan

Harmonic Drive AG
Hoenbergstrasse, 14, D-6555
Limburg/Lahn Germany

Harmonic Drive®, Harmonic Gearhead®, Harmonic Planetary® and Quick Connect® are registered trademarks of Harmonic Drive LLC. All other trademarks are property of their respective owners.

