





Warning : Means that improper use or handling could result in a risk of death or serious injury.









Caution : Means that improper use or handling could result in personal injury or damage to property.





This product cannot be used for the following applications:

- * Space flight hardware
- * Aircraft equipment
- * Nuclear power equipment
- * Equipment and apparatus used in domestic homes
- * Vacuum environments
- * Automotive equipment
- * Personal recreation equipment
- * Equipment that directly works on human bodies
- * Equipment for transport of humans
- * Equipment for use in a special environment
- * Medical equipment

Please consult Harmonic Drive LLC beforehand if intending to use one of our product for the aforementioned applications. Fail-safe devices that prevent an accident must be designed into the equipment when the products are used in any equipment that could result in personal injury or damage to property in the event of product failure.

Design Precaution: Be certain to read the catalog when designing the equipment.	
 Caution	<p>Use only in the proper environment.</p> <ul style="list-style-type: none"> ● Please ensure to comply with the following environmental conditions: <ul style="list-style-type: none"> • Ambient temperature 0 to 40°C • No splashing of water or oil • Do not expose to corrosive or explosive gas • No dust such as metal powder
 Caution	<p>Install the equipment with the required precision.</p> <ul style="list-style-type: none"> ● Design and assemble parts to keep all catalog recommended tolerances for installation. ● Failure to hold the recommended tolerances can cause problems such as vibration, reduction in life, deterioration of precision and product failure.
 Caution	<p>Install the equipment properly.</p> <ul style="list-style-type: none"> ● Carry out the assembly and installation precisely as specified in the catalog. ● Observe our recommended fastening methods (including bolts used and tightening torques). ● Operating the equipment without precise assembly can cause problems such as vibration, reduction in life, deterioration of precision and product failure.
 Caution	<p>Use the specified lubricant.</p> <ul style="list-style-type: none"> ● Using other than our recommended lubricant can reduce the life of the product. Replace the lubricant as recommended. ● Gearheads are factory lubricated. Do not mix installed lubricant with other kinds of grease.

Operational Precaution: Be certain to read the catalog before operating the equipment.	
 Caution	<p>Use caution when handling the product and parts.</p> <ul style="list-style-type: none"> ● Do not hit the gear or any part with a hammer. ● If you use the equipment in a damaged condition, the gearhead may not perform to catalog specifications. It can also cause problems including product failure.
 Caution	<p>Do not alter or disassemble the product or parts.</p> <ul style="list-style-type: none"> ● Harmonic Planetary® and Harmonic Drive® products are manufactured as matched sets. Catalog rated performance may not be achieved if the component parts are interchanged.
 Warning	<p>Do not use your finger to turn the gear.</p> <ul style="list-style-type: none"> ● Do not insert your finger into the gear under any circumstances. The finger may get caught in the gear causing an injury.
 Warning	<p>Large model Nos. (45, 50 and 65) are heavy. Use caution when handling.</p> <ul style="list-style-type: none"> ● They are heavy and may cause a lower-back injury or an injury if dropped on a hand or foot. Wear protective shoes and back support when handling the product.
 Caution	<p>Operate within the allowable torque range.</p> <ul style="list-style-type: none"> ● Do not apply torque exceeding the momentary peak torque. Applying excess torque can cause problems such as loosened bolts, generation of backlash and product failure. ● An arm attached directly to the output shaft that strikes a solid object can damage the arm or cause the output of the gearhead to fail.
 Caution	<p>Do not disassemble the products.</p> <ul style="list-style-type: none"> ● Do not disassemble and reassemble the products. Original performance may not be achieved.
 Caution	<p>Stop operating the system if any abnormality occurs.</p> <ul style="list-style-type: none"> ● Shut down the system promptly if any abnormal sound or vibration is detected, the rotation has stopped, an abnormally high temperature is generated, an abnormal motor current value is observed or any other anomalies are detected. Continuing to operate the system without stopping may adversely affect the product or equipment. ● Please contact our sales office or distributor if any anomaly is detected.
 Caution	<ul style="list-style-type: none"> ● Rust-proofing was applied before shipping. However, please note that rusting may occur depending on the customers' storage environment. ● Although black oxide finish is applied to some of our products, it does not guarantee that rust will not form.

Handling Lubricant	
 Warning	<p>Precautions on handling lubricants</p> <ul style="list-style-type: none"> ● Lubricant in the eye can cause inflammation. Wear protective glasses to prevent it from getting in your eye. ● Lubricant coming in contact with the skin can cause inflammation. Wear protective gloves when you handle the lubricant to prevent it from contacting your skin. ● Do not eat it (to avoid diarrhea and vomiting). ● Use caution when opening the container. There may be sharp edges that can cut your hand. Wear protective gloves. ● Keep lubricant out of reach of children.
 Warning	<p>First-aid</p> <ul style="list-style-type: none"> ● Inhalation: Remove exposed person to fresh air if adverse effects are observed. ● Ingestion: Seek immediate medical attention and do not induce vomiting unless directed by medical personnel. ● Eye: Flush immediately with water for at least 15 minutes. Get immediate medical attention. ● Skin: Wash with soap and water. Get medical attention if irritation develops.
 Caution	<p>Disposal of waste oil and containers</p> <ul style="list-style-type: none"> ● Follow all applicable laws regarding waste disposal. Contact your distributor if you are unsure how to properly dispose of the material. ● Do not apply pressure in an empty container. The container may blow up. ● Do not weld, heat, drill or cut the container. This may cause residual oil to ignite or cause an explosion.
 Caution	<p>Storage</p> <ul style="list-style-type: none"> ● Tightly seal the container after use. Store in a cool, dry, dark place. Keep away from open flames and high temperatures.
 Caution	<p>Disposal</p> <ul style="list-style-type: none"> ● *Please dispose as industrial waste. ● Please dispose of the products as industrial waste when their useful life is over.

*When disposing of the product, disassemble it and sort the component parts by material type and dispose of the parts as industrial waste in accordance with the applicable laws and regulations. The component part materials can be classified into three categories.

(1) Rubber parts: Oil seals, seal packings, rubber caps, seals of shielded bearings on input side (DDU type only)
 (2) Aluminum parts: Housings, motor flanges
 (3) Steel parts: Other parts

Warranty

EXCLUSIVE WARRANTY: Seller warrants that new and unused product sold by Seller shall be free from defects in material or workmanship for a period of one (1) year from the date shipment. THIS WARRANTY IS EXCLUSIVE AND IS IN LIEU OF ANY OTHER WARRANTY, EXPRESS OR IMPLIED, INCLUDING, BUT NOT LIMITED TO, ANY IMPLIED WARRANTY OF MERCHANTABILITY, FITNESS FOR A PARTICULAR PURPOSE OR INFRINGEMENT.

The Buyer shall promptly notify Seller in writing of any alleged defect. Warranty claims must be made by the Buyer who originally purchased the product from Seller. This warranty is not transferrable to a third party.

The Seller's obligation under this warranty is limited to circumstances where the product has been used under normal conditions for which it was designed and has been installed, operated and maintained in accordance with the product specification and handling instructions. This Warranty does not cover defects which were the result of misuse, improper installation or repair, alterations or modifications by the Buyer or any third party, any natural disaster or any loss, damage, defect, claim or non-performance resulting from or attributable to the Buyer's use of the product outside the range of the Seller's specifications.

Model and code examples

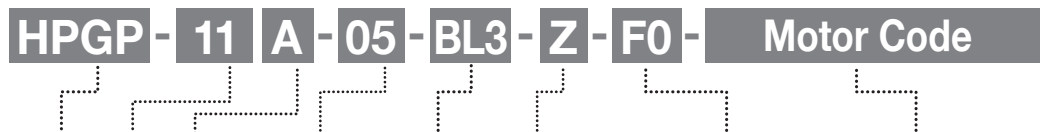

Model Name	Size	Design Revision	Reduction Ratio	Backlash	Input Side Bearing	Output Configuration	Input Configuration & Options
HarmonicPlanetary* HPGP High Torque	11	A	5, 21, 37, 45	BL1: Backlash less than 1 arc-min (Sizes 14 to 65)	Z: Input side bearing with double non-contact shields D: Input side contact sealed bearing (Recommended for output flange up orientation.)	F0: Flange output J20: Shaft output without key J60: Shaft output with key and center tapped hole	This code represents the motor mounting configuration. Please contact us for a unique part number based on the motor you are using.
	14		5, 11, 15, 21, 33, 45				
	20						
	32						
	50						
65	4, 5, 12, 15, 20, 25	BL3: Backlash less than 3 arc-min	F0: Flange output J2: Shaft output without key J6: Shaft output with key and center tapped hole (J2, J6 for Size 65 is also available)				



Model Name	Size	Reduction Ratio	Model	Output Configuration	Input Configuration
HarmonicDrive* CSF Standard	14	50, 80, 100	GH: Gearhead	F0: Flange output J2: Shaft output without key J6: Shaft output with key and center tapped hole	This code represents the motor mounting configuration. Please contact us for a unique part number based on the motor you are using.
	20	50, 80, 100, 120, 160			
	32				
	45				
	65				

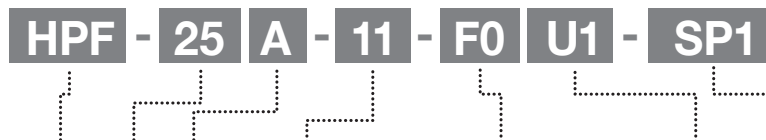

Model Name	Size	Design Revision	Reduction Ratio	Output Configuration	Input Configuration	Options
HarmonicPlanetary* HPF Hollow Shaft	25	A	11	F0: Flange output	U1: Hollow input shaft	None: Standard item SP: Special specification
	32					

All efforts have been made to ensure that the information in this catalog is complete and accurate. However, Harmonic Drive LLC is not liable for any errors, omissions or inaccuracies in the reported data. Harmonic Drive LLC reserves the right to change the product specifications, for any reason, without prior notice. For complete details please refer to our current Terms and Conditions posted on our website.

Assembly

Assemble and mount your gearhead in accordance with these instructions to achieve the best performance. Be sure to use the recommended bolts and use a torque wrench to achieve the proper tightening torques as recommended in the tables below.

Motor assembly procedure

HPGP

HPG

CSG-GH

CSF-GH

HPN

To properly mount the motor to the gearhead, follow the procedure outlined below, refer to figure 3-1

- (1) Turn the input shaft coupling and align the bolt head with the rubber cap hole.
- (2) With the speed reducer in an upright position as illustrated in the figure below, slowly insert the motor shaft into the coupling of speed reducer. Slide the motor shaft into the input shaft coupling by guiding the motor shaft into it without letting it drop down. If the speed reducer cannot be positioned upright, slowly insert the motor shaft into the coupling of speed reducer, then tighten the motor bolts evenly (little by little) until the motor flange and gearhead flange are in full contact. Exercise care to avoid tilting the motor when inserting it into the gear head.
- (3) Tighten the input shaft coupling bolt to the recommended torque specified in the table below. The bolt(s) or screw(s) is (are) already inserted into the input shaft coupling when delivered. Check the bolt size on the confirmation drawing provided.

Bolt tightening torque

Table 3-1

Bolt size		M3	M4	M5	M6	M8	M10	M12
Tightening torque	Nm	2.0	4.5	9.0	15.3	37.2	73.5	128
	kgfm	0.20	0.46	0.92	1.56	3.8	7.5	13.1

Caution: Always tighten the bolts to the tightening torque specified in the table above. If the bolt is not tightened to the torque value recommended slippage of the motor shaft in the shaft coupling may result. The bolt size will vary depending on the size of the gear and the shaft diameter of the mounted motor. Check the bolt size on the confirmation drawing provided.

Note: Two setscrews need to be tightened on size 11. Tighten the screws to the tightening torque specified below.

Table 3-2

Bolt size		M3
Tightening torque	Nm	0.69
	kgfm	0.07

- (4) Fasten the motor to the gearhead flange with bolts.

Bolt* tightening torque

Table 3-3

Bolt size		M2.5	M3	M4	M5	M6	M8	M10	M12
Tightening torque	Nm	0.59	1.4	3.2	6.3	10.7	26.1	51.5	89.9
	kgfm	0.06	0.14	0.32	0.64	1.09	2.66	5.25	9.17

* Recommended bolt: JIS B 1176 Hexagon socket head bolt, Strength: JIS B 1051 12.9 or higher

Caution: Be sure to tighten the bolts to the tightening torques specified in the table.

- (5) Insert the rubber cap provided. This completes the assembly. (Size 11: Fasten screws with a gasket in two places)

Figure 3-1

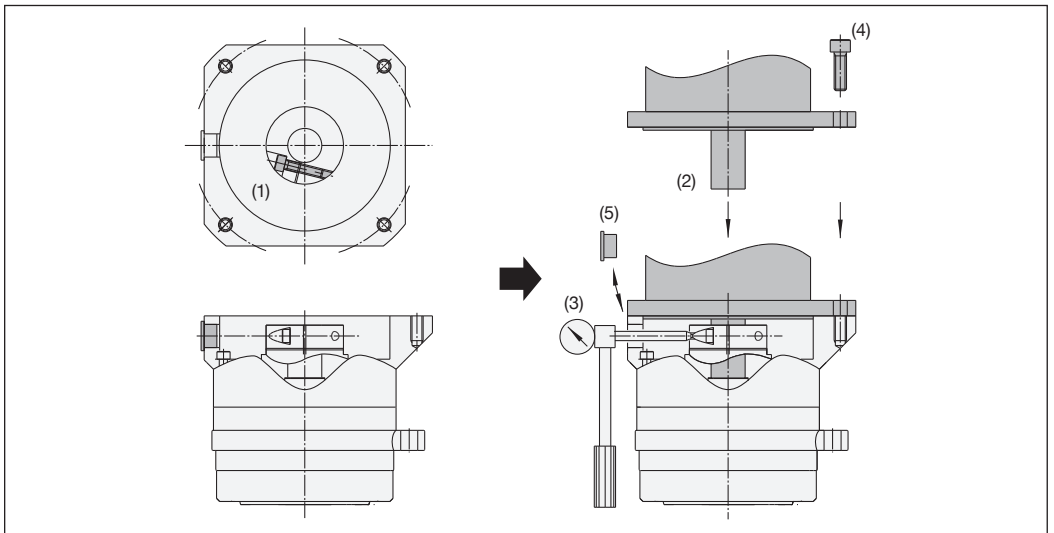

Speed reducer assembly

HPGP
HPG
CSG-GH
CSF-GH
HPF
HPN

Some right angle gearhead models weigh as much as 130 lbs (60 kg). No thread for an eyebolt is provided because the mounting orientation varies depending on the customer's need. When mounting the reducer, hoist it using a sling paying extreme attention to safety.

When assembling gearheads into your equipment, check the flatness of your mounting surface and look for any burrs on tapped holes. Then fasten the flange (Part A in the diagram below) using appropriate bolts.

Bolt* tightening torque for flange (Part A in the diagram below)

Table 4-1

Size	HPN					HPGP / HPG / CSG-GH / CSF-GH						HPF		
	11	14	20	32	40	11	14	20	32	45/50	65	25	32	
Number of bolts	4	4	4	4	4	4	4	4	4	4	4	12	12	
Bolt size	M3	M5	M6	M8	M10	M3	M5	M8	M10	M12	M16	M4	M5	
Mounting PCD	mm	50	70	100	130	165	46	70	105	135	190	260	127	157
	Nm	1.4	6.3	10.7	26.1	51.5	1.4	6.3	26.1	51.5	103	255	4.5	9.0
Tightening torque	kgfm	0.14	0.64	1.09	2.66	5.26	0.14	0.64	2.66	5.25	10.5	26.0	0.46	0.92
	Nm	27.9	110	223	528	1063	26.3	110	428	868	2030	5180	531	1060
Transfer torque	kgfm	2.85	11.3	22.8	53.9	108.5	2.69	11.3	43.6	88.6	207	528	54.2	108

* Recommended bolts: JIS B 1176 "Hexagon socket head bolts." Strength classification 12.9 or higher in JIS B 1051.

Mounting the load to the output flange

Follow the specifications in the table below when mounting the load onto the output flange.

Figure 4-1

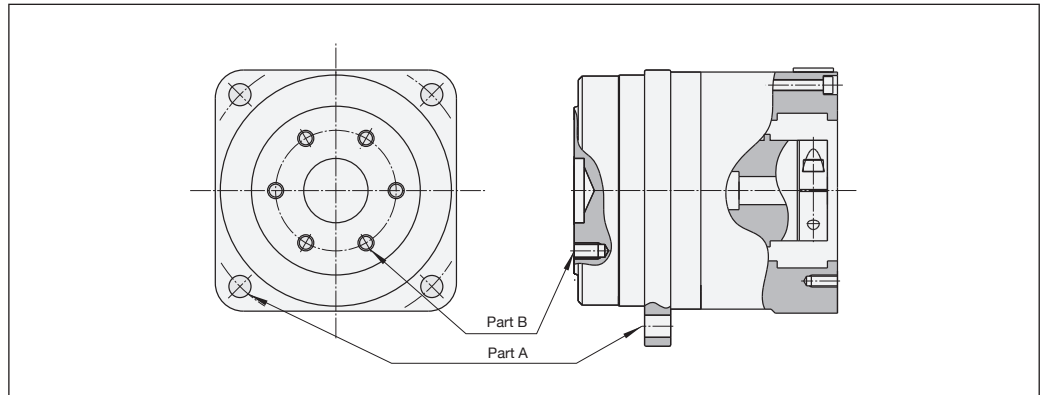

Output flange mounting specifications

Bolt* tightening torque for output flange (Part B in the Figure 4-1)

HPGP

Table 4-2

Size	11	14	20	32	50	65	
Number of bolts	4	8	8	8	8	8	
Bolt size	M4	M4	M6	M8	M12	M16	
Mounting PCD	mm	18	30	45	60	90	120
	Nm	4.5	4.5	15.3	37.2	128.4	319
Tightening torque	kgfm	0.46	0.46	1.56	3.8	13.1	32.5
	Nm	25.3	84	286	697	2407	5972
Transmission torque	kgfm	2.58	8.6	29.2	71.2	245	609

Bolt* tightening torque for output flange (Part B in the Figure 4-1)

HPG

Table 4-3

Size	11	14	20	32	50	65	
Number of bolts	3	6	6	6	14	6	
Bolt size	M4	M4	M6	M8	M8	M16	
Mounting PCD	mm	18	30	45	60	100	120
	Nm	4.5	4.5	15.3	37.2	37.2	319
Tightening torque	kgfm	0.46	0.46	1.56	3.8	3.80	32.5
	Nm	19.0	63	215	524	2036	4480
Transmission torque	kgfm	1.9	6.5	21.9	53.4	207.8	457

* Recommended bolts: JIS B 1176 "Hexagon socket head bolts." Strength classification 12.9 or higher in JIS B 1051.

■ Mounting the load to the output flange

Bolt* tightening torque for output flange (Part B in Figure 6-1)

CSG-GH

Table 5-1

Size		14	20	32	45	65
Number of bolts		8	8	10	10	10
Bolt size		M4	M6	M8	M12	M16
Mounting PCD	mm	30	45	60	94	120
Tightening torque	Nm	4.5	15.3	37	128	319
	kgfm	0.46	1.56	3.8	3.1	32.5
Transmission torque	Nm	84	287	867	3067	7477
	kgfm	8.6	29.3	88.5	313	763

Bolt* tightening torque for output flange (Part B in Figure 6-1)

CSF-GH

Table 5-2

Size		14	20	32	45	65
Number of bolts		6	6	6	16	8
Bolt size		M4	M6	M8	M8	M16
Mounting PCD	mm	30	45	60	100	120
Tightening torque	Nm	4.5	15.3	37.2	37.2	319
	kgfm	0.46	1.56	3.80	3.80	32.5
Transmission torque	Nm	63	215	524	2326	5981
	kgfm	6.5	21.9	53.4	237	610

Bolt* tightening torque for output flange
(Part B in Figure 6-1)

HPF

Table 5-3

Size		25	32
Number of bolts		12	12
Bolt size		M4	M5
Mounting PCD	mm	77	100
Tightening torque	Nm	4.5	9.0
	kgfm	0.46	0.92
Transmission torque	Nm	322	675
	kgfm	32.9	68.9

* Recommended bolts: JIS B 1176 "Hexagon socket head bolts." Strength classification 12.9 or higher in JIS B 1051.

Gearheads with an output shaft

HPN

HPG

HPGP

CSG-GH

CSF-GH

HPF

Do not subject the output shaft to any impact when mounting a pulley, pinion or other parts.

An impact to the the output bearing will deteriorate the speed reducer precision and may cause reduced life or failure.

Mechanical Tolerances

Superior mechanical precision is achieved by integrating the output flange with a high-precision cross roller bearing as a single component. The mechanical tolerances of the output shaft and mounting flange are specified below.

Figure 6-1

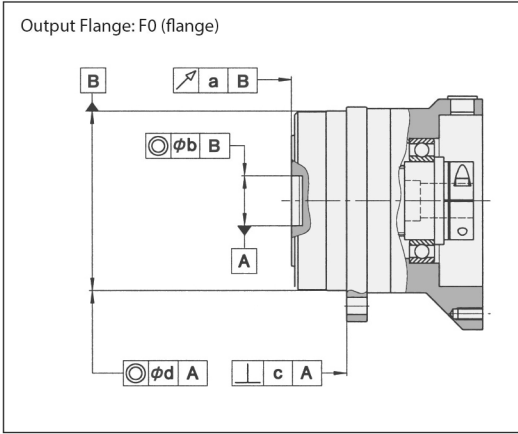
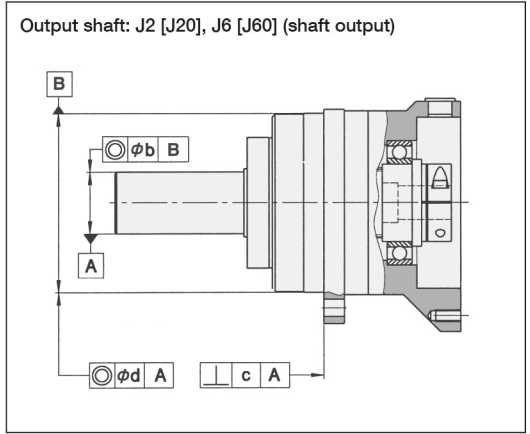

Figure 6-2



HPGP **HPG** **CSG-GH** **CSF-GH**

Table 6-1

Size	Axial runout of output flange a	Radial runout of output flange pilot or output shaft b	Perpendicularity of mounting flange c	Concentricity of mounting flange d
11	0.020	0.030	0.050	0.040
14	0.020	0.040	0.060	0.050
20	0.020	0.040	0.060	0.050
32	0.020	0.040	0.060	0.050

HPGP **HPG**

Table 6-2

50	0.020	0.040	0.060	0.050
65	0.040	0.060	0.090	0.080

CSG-GH **CSF-GH**

Table 6-3

45	0.020	0.040	0.060	0.050
65	0.020	0.040	0.060	0.050

HPF

Table 6-4

25	0.020	0.040	0.060	0.050
32	0.020	0.040	0.060	0.050

* T.I.R.: Total indicator reading

(T.I.R.: Unit: mm)

Lubrication

Prevention of grease and oil leakage

(Common to all models)

- Only use the recommended greases.
- Provisions for proper sealing to prevent grease leakage are incorporated into the gearheads. However, please note that some leakage may occur depending on the application or operating condition. Discuss other sealing options with our applications engineers.
- When mounting the gearhead horizontally position the gearhead so the rubber cap in the adapter flange is facing upwards.

(CSG/CSF-GH Series)

- Contact us when using HarmonicDrive® CSG/CSF-GH series with the output shaft facing downward (motor on top) at a constant load or rotating continuously in one direction.

Sealing

(Common to all models)

- Provisions for proper sealing to prevent grease leakage from the input shaft are incorporated into the gearhead.
- A double lip Teflon oil seal is used for the output shaft (HPGP/HPG uses a single lip seal), gaskets or o-rings are used on all mating surfaces, and non contact shielded bearing are used for the motor shaft coupling (Double sealed bearings (D type) are available as an option*) . On the CSG/CSF-GH series, non contact shielded bearing and a Teflon oil seal with a spring is used.

* D type: Bearing with a rubber contact seal on both sides

(HPG/HPGP/HPF/HPN Series)

- Using the doubled sealed bearing (D type) for the HPGP/HPG series gearhead will result in a slightly lower efficiency compared to the standard product.
- An oil seal without a spring is used in the input shaft side of HPG series with an input shaft (HPG-1U) and HPF series hollow shaft reducer. An option for an oil seal with a spring is available for improved seal reliability, however, the efficiency will be slightly lower (available for HPF and HPG series for sizes 14 and larger).
- Do not remove the screw plug and seal cap of the HPG series right angle gearhead. Removing them may cause leakage of grease or affect the precision of the gear.

Lubricant

HPG/HPGP/HPF/HPN Series

The standard lubrication for the HPG/HPGP/HPF/HPN series gearheads is grease.

All gearheads are lubricated at the factory prior to shipment and additional application of grease during assembly is not required.

The gearheads are lubricated for the life of the gear and do not require re-lubrication.

High efficiency is achieved through the unique planetary gear design and grease selection.

Lubricants

Harmonic Grease® SK-2 (HPGP/HPG-14, 20, 32)

Manufacturer: Harmonic Drive Systems Inc.

Base oil: Refined mineral oil	Consistency: 265 to 295 at 25°C
Soap radical: Lithium soap	Dropping point: 198°C
Additive: Extreme pressure agent and other	Product appearance: Green
Standard: NLGI No. 2	

EPNOC Grease AP (N) 2 (HPGP/HPG-11, 50, 65 / HPF-25, 32)

Manufacturer: Nippon Oil Co.

Base oil: Refined mineral oil	Consistency: 282 at 25°C
Soap radical: Lithium soap	Dropping point: 200°C
Additive: Extreme pressure agent and other	Product appearance: Light brown
Standard: NLGI No. 2	

PYRONOC UNIVERSAL 00 (HPG right angle gearhead/HPN)

Manufacturer: Nippon Oil Co.

Base oil: Refined mineral oil	Consistency: 420 at 25°C
Soap radical: Urea	Dropping point: 250°C or higher
Standard: NLGI No. 00	Product appearance: Light yellow

MULTEMP AC-P (HPG-X-R)

Manufacturer: KYODO YUSHI CO, LTD

Base oil: Composite hydrocarbon oil and diester	Standard: NLGI No. 2
Thickening agent: Lithium soap	Consistency: 280 at 25°C
Additive: Extreme pressure and others	Dropping point: 200°C
	Color: Black viscose

Ambient operating temperature range: -10°C to +40°C

The lubricant may deteriorate if the ambient operating temperature is too high or too low. Please contact our sales office or distributor for operation outside of the ambient operating temperature range.

The temperature rise of the gear depends upon the operating cycle, ambient temperature and heat conduction and radiation as affected by the customers installation of the gear. A housing surface temperature of 70°C is the maximum allowable limit.

CSG-GH/CSF-GH Series

The standard lubrication for the CGS-GH / CSF-GH series gearheads is grease.

All gearheads are lubricated at the factory prior to shipment and additional application of grease during assembly is not necessary.

Lubricants

Harmonic Grease® SK-1A (Size 20, 32, 45, 65)
Manufacturer: Harmonic Drive Systems Inc.

This has been developed exclusively for HarmonicDrive® gears and is excellent in durability and efficiency compared to commercial general-purpose grease.

Base oil: Refined mineral oil
Soap radical: Lithium soap
Additive: Extreme pressure agent and other
Standard: NLGI No. 2

Consistency: 265 to 295 at 25°C
Dropping point: 197°C
Product appearance: Yellow

Harmonic Grease® SK-2 (Size 14)
Manufacturer: Harmonic Drive Systems Inc.

This has been developed exclusively for smaller sized HarmonicDrive® gears and allows smooth wave generator rotation.

Base oil: Refined mineral oil
Soap radical: Lithium soap
Additive: Extreme pressure agent and other
Standard: NLGI No. 2

Consistency: 265 to 295 at 25°C
Dropping point: 198°C
Product appearance: Green

Ambient operating temperature range: -10°C to +40°C

The lubricant may deteriorate if the ambient operating temperature is too high or too low. Please contact our sales office or distributor for operation outside of the ambient operating temperature range.

The temperature rise of the gear depends upon the operating cycle, ambient temperature and heat conduction and radiation as affected by the customers installation of the gear. A housing surface temperature of 70°C is the maximum allowable limit.

When to change the grease

The life of the Harmonic Drive® gear is affected by the grease performance. The grease performance varies with temperature and deteriorates with temperatures. Therefore, the grease will need to be changed sooner than usual when operating at higher temperatures. The graph on the right indicates when to change the grease based upon the temperature and the total number of input rotations when the average load torque is less than or equal to the rated output torque at 2000 rpm. Also, using the formula below, you can calculate when to change the grease when the average load torque exceeds the rated output torque at 2000 rpm.

Formula to calculate the grease change interval when the average load torque exceeds the rated torque

Formula 8-1

$$L_{GT} = L_{GTn} \times \left(\frac{T_r}{T_{av}} \right)^3$$

Formula symbols

Table 8-1

L_{GT}	Grease change interval when $T_{av} > T_r$	Input rotations
L_{GTn}	Grease change interval when $T_{av} \leq T_r$	Input rotations
T_r	Output torque at 2000 rpm	Nm, kgfm
T_{av}	Average load torque	Nm, kgfm

When to change the grease:
LGTn (when the average load torque is equal to or less than the rated output torque at 2000 rpm)

Figure 8-1

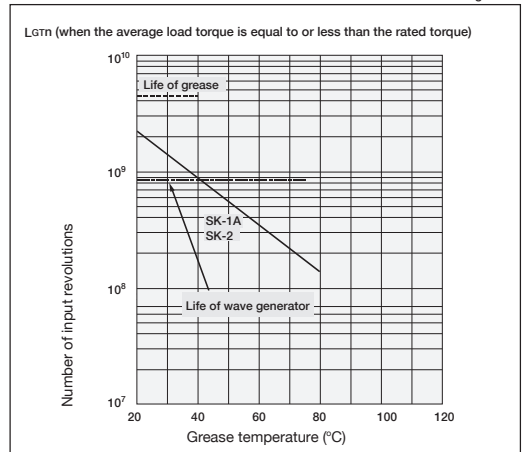

* L10 Life of wave generator bearing

Grease quantity for Reference value of grease refill amount for replacement

Table 8-2

Size	14	20	32	45	65
Amount: g	0.8	3.2	6.6	11.6	78.6

Precautions when changing the grease

Strictly observe the following instructions when changing the grease to avoid problems such as grease leakage or increase in running torque.

- Note that the amount of grease listed in Table 8-2 is the amount used to lubricate the gear at assembly. This should be used as a reference. Do not exceed this amount when re-greasing the gearhead.
- Remove grease from the gearhead and refill it with the same quantity. The adverse effects listed above normally do not occur until the gear has been re-greased 2 times. When re-greasing 3 times or more, it is essential to remove grease (using air pressure or other means) before re-lubricating with the same amount of grease that was removed.



Harmonic Drive LLC
247 Lynnfield Street, Peabody, MA
www.harmonicdrive.net

Harmonic Drive, Harmonic Grease and Harmonic Planetary are registered trademarks of Harmonic Drive LLC.

20160926